



CAMBRIDGE CARES CAMBRIDGE CENTRE
FOR ADVANCED RESEARCH AND
EDUCATION IN SINGAPORE LTD.

Biannual Research Report

May 2018 — October 2018

CAM.CREATE
C4T

- Cambridge
- Centre for
- Carbon Reduction in
- Chemical Technology

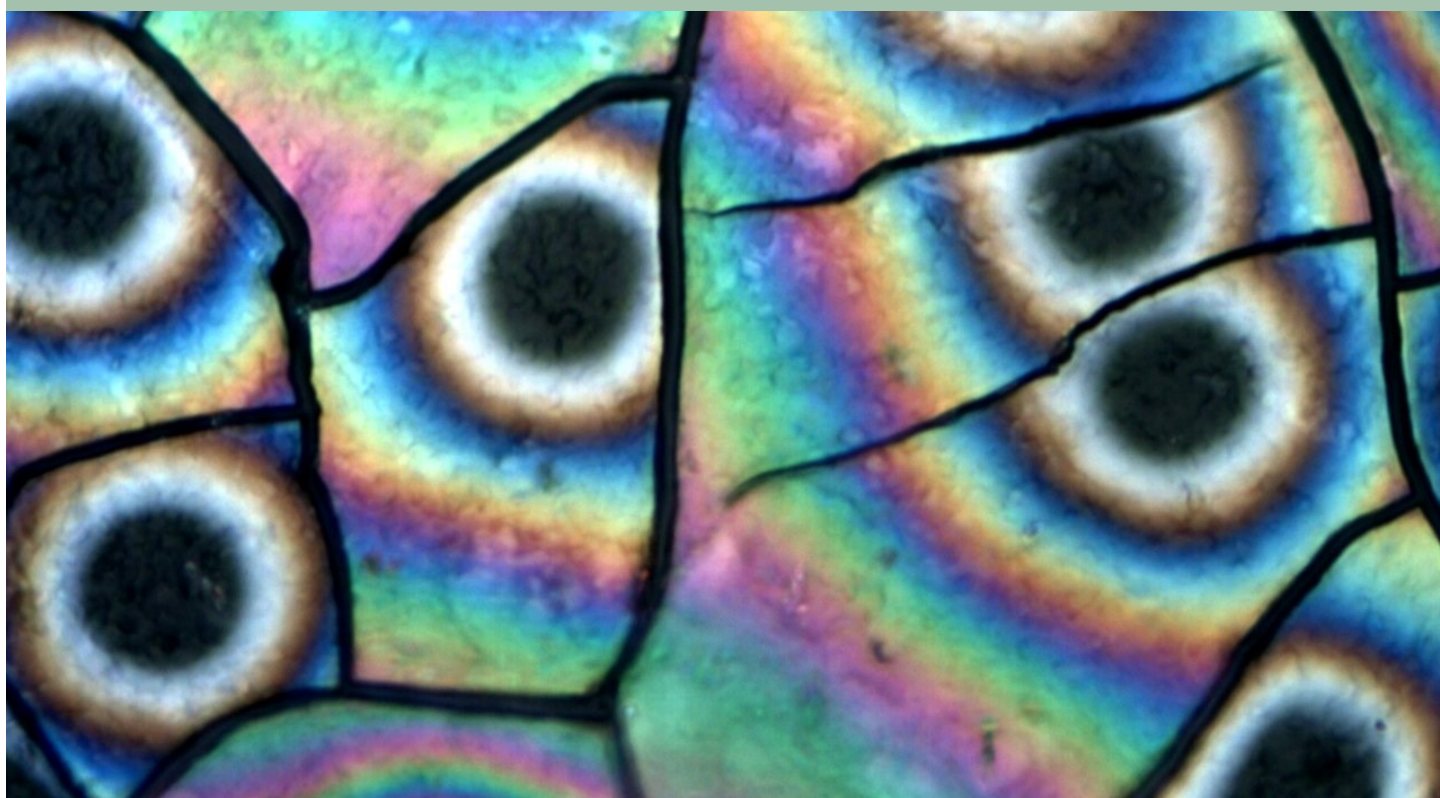

CREATE

Campus for Research Excellence And Technological Enterprise

University of Cambridge
Nanyang Technological University
National University of Singapore

Cover image

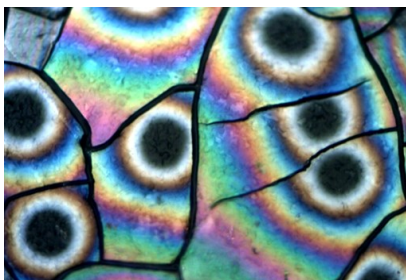

A thin film of layered double hydroxide nanoplatelets. The interesting colours come from how the platelets interact with light.

Image by Nicholas Jose, PhD student, IRP1.

Produced by

CAMBRIDGE CENTRE FOR ADVANCED RESEARCH
AND EDUCATION IN SINGAPORE LTD.

Registration No. 201302109Z

1 Create Way, #05-05 CREATE Tower
Singapore, 138602

cares@hermes.cam.ac.uk

<http://www.cares.cam.ac.uk>



10

Catalytic CO₂ hydrogenation

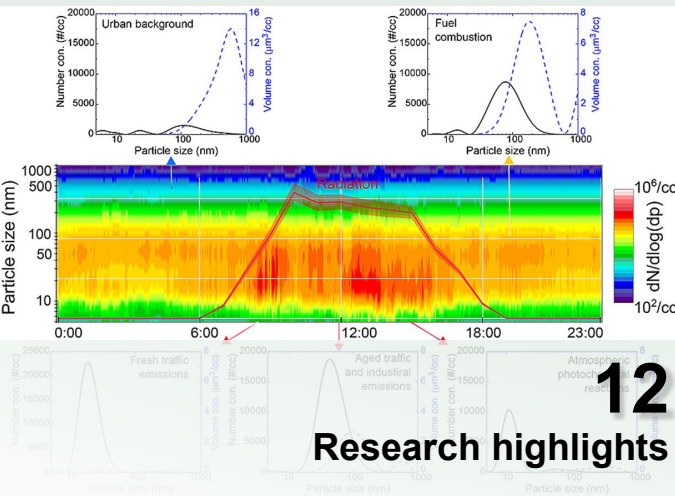

12

Research highlights

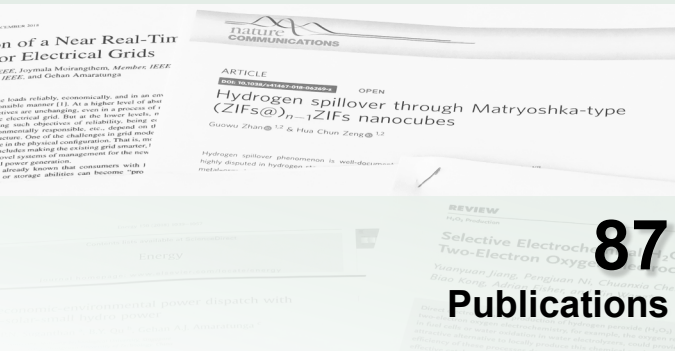

87

Publications



111

Visiting Scientists

Contents

- 4 Foreword
- 5 About Us

Highlights

- 8 Focus on Impact
- 10 Focus on Fundamental Science
- 12 Research Highlights

Programme Updates

- 21 C4T IRP 1
- 35 C4T IRP 2
- 49 C4T IRP 3
- 65 C4T IRP 4
- 79 eCO₂EP

Facts and Figures

- 87 Publications
- 111 C4T Visiting Scientists Programme



FOREWORD

I am very pleased to present the 9th Biannual Research Report of the Cambridge Centre for Advanced Research and Education in Singapore (CARES). This is our final scientific report of the first phase of C4T – Cambridge Centre for Carbon Reduction in Chemical Technology – and I am happy to report that the National Research Foundation Singapore (NRF) has awarded funding for C4T Phase 2. This report contains the latest C4T research as well as an update on the progress of our first Intra-CREATE programme, eCO₂EP.

PHASE 2

C4T Phase 2 commences in November 2018. It builds on our Phase 1 research and includes two new Interdisciplinary Research Programmes (IRPs). IRP Better Business will focus on how we can best integrate and apply our research to industry here in Singapore and there is a new, separate IRP for the J-Park Simulator (part of IRP3 in Phase 1). Our IRP4 programme on the Jurong Island electrical sub-network comes to an end with Phase 1, but I am very impressed with the excellent work done by the IRP4 researchers. We enjoyed the opportunity to hear from them at the IRP4 research review symposium in October, and I would encourage you to take a look at their report on page 65. The new Phase 2 IRP4 will focus on waste heat utilisation.

VISITORS

Over the last six months we have hosted three Visiting Scientists, all of whom gave excellent talks on their latest research, and arranged two further guest seminars. These visits are always beneficial for the students especially, both to find out more about their own areas of research from international experts and to hear about other subjects. You can read more about the C4T Visiting Scientist series on page 111.

We were also fortunate to host several interns this year, most for a period of several months, and greatly value their curiosity and hard work along with the friendships formed during their stay.

INTRA-CREATE

CARES' first Intra-CREATE programme, eCO₂EP ("A table top chemical factory for the reduction of CO₂ to value added chemicals") is progressing well and has started to generate research outputs. You will find their latest research update on page 79.

HIGHLIGHTS

We were delighted to host the Vice-Chancellor of Cambridge University, Professor Stephen Toope, twice during the last reporting period. We gave him an overview of CARES and had the opportunity to demonstrate some of our nanomaterials work.

Many of our students and postdocs presented work at the science and technology event SWITCH in Singapore, which was a wonderful opportunity to build links with industry. CARES also had a research display at the Cambridge University alumni event, which was attended by the Vice-Chancellor.

LOOKING AHEAD

We are excited to continue our existing research projects and to welcome new members to CARES in Phase 2. We also look forward to a visit from our Scientific Advisory Committee to Singapore in March, when we will present some of our early Phase 2 research.

I hope I have encouraged you to read more about CARES' latest work and achievements in this report. As ever, please do get in touch if you have any questions or see opportunity for collaboration.

Prof. Markus Kraft, CARES Director
October 2018



ABOUT US

Cambridge CARES is the University of Cambridge's presence in Singapore

The Cambridge Centre for Advanced Research and Education in Singapore (CARES) is a wholly-owned subsidiary of the University of Cambridge. CARES is funded by the National Research Foundation as part of CREATE (Campus for Research Excellence and Technological Enterprise). We have a number of research collaborations between the University of Cambridge, Nanyang Technological University, the National University of Singapore and industrial partners.

The first programme administered by CARES is the Cambridge Centre for Carbon Reduction in Chemical Technology (C4T). The C4T programme is a world-leading partnership between Cambridge and Singapore, set up to tackle the environmentally relevant and complex problem of assessing and reducing the carbon footprint of the integrated petro-chemical plants and electrical network on Jurong Island in Singapore. It brings together researchers from chemical engineering, biotechnology, chemistry, biochemistry, information engineering, electrical engineering, materials science and metallurgy.

The motivation for the C4T project is to integrate materials design and selection (i.e. for adsorbents and catalysts) with advances in process design to achieve improved selectivity and conversion. Such improvements will provide a reduced carbon footprint and energy demand for both established and new processes. Lowering the cost of CO₂ capture, and technologies and strategies for waste heat utilisation are also underlying drivers in the research. These four collaborative Interdisciplinary Research Programmes (IRPs) combine state-of-the-art experimental analysis with advanced modelling research from Cambridge and Singapore. Whilst each IRP has clearly defined milestones and deliverables, denoted as work packages (WPs), there is significant interaction between the IRPs.

The first five-year research phase of C4T came to an end in October 2018. The programme has received a further five years of funding, commencing in November 2018.



IRP 1: Multi-Scale Studies of Catalytic and Adsorption Technologies (MUSCAT)

IRP 2: Electrochemical Multi-Scale Science, Engineering and Technology (EMSET)

IRP 3: Carbon Abatement in the Petroleum Refining Industry: A Control and Optimisation Research Network (CAPRICORN)

IRP 4: Integrated Chemicals and Electrical Systems Operation (ICESO)

The second programme administered by CARES is eCO₂EP, a three-year programme that brings together researchers from the University of Cambridge, the University of California, Berkeley, the National University of Singapore (NUS) and Nanyang Technological University (NTU) to develop ways of transforming carbon dioxide emitted as part of the industrial process into compounds that are useful in the chemical industry supply chain.

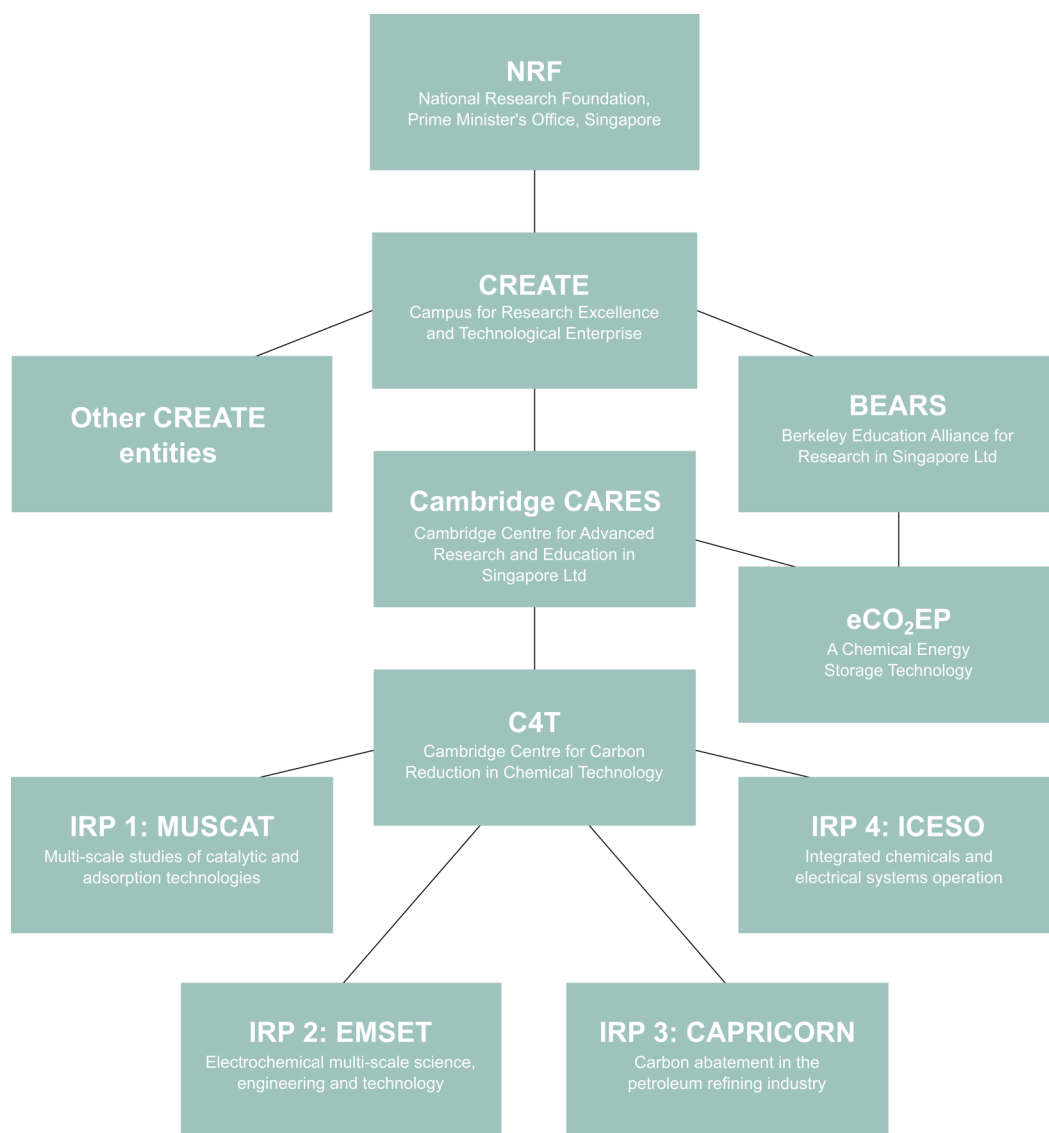



Coupling orientation and mediation strategies for efficient electron transfer in hybrid biofuel cells

Kamal Elouarzaki^{1,2,3}, Daojian Cheng^{2,4}, Adrian C. Fisher^{2,5,6} and Jong-Min Lee^{1,2*}

Enzymes are promising electrocatalysts for electron transfer (ET) in many biological processes. Strategies to enhance ET between enzymes and electroactive surfaces include orientation and immobilization of the enzymes and electron mediation achieved by the synthesis of a redox mediator and electron mediation on electrodes based on carbon nanotubes. This mediator (2'-amino-bis(3-ethylbenzothiazoline-6-sulfonic acid) (ABTS)) and an electropolymerizable monomer (pyrrole). The coupling of an enzymatic orientation and a mediated ET in the same chemical structure (pyrrole-ABTS-pyrrole (pyr-ABTS-pyr)) provides a much-improved performance. In a proton-exchange membrane hydrogen/air fuel cell and in a membraneless fuel cell, the synthesized bioanode provides a power density of 1.07 mW cm⁻² and 2.9 mW cm⁻², respectively. The principle of coupling an enzyme orientation and a redox mediator allows a great variety of mediators to be engineered and provides vast possibilities for the development of hybrid biofuel cells.

Among these methods, DET is influenced strongly

THE JOURNAL OF PHYSICAL CHEMISTRY C

Flexoelectricity and the Formation of Carbon Nanoparticles in Flames

Jacob W. Martin^{1,2*}, Maria Botero^{1,2}, Radomir I. Slavchov¹, Kimberly Bowal¹, Jethro Akroyd¹, Sebastian Mosbach¹, and Markus Kraft^{1,2,3,4,5,6}

¹Department of Chemical Engineering and Biotechnology, University of Cambridge, Cambridge CB3 0AS, U.K.
²Cambridge Centre for Advanced Research and Education in Singapore (CARES), Singapore 38602
³Department of Mechanical Engineering, National University of Singapore, Singapore 117576
⁴School of Chemical and Biomedical Engineering, Nanyang Technological University, Singapore 637459

Supporting Information

ABSTRACT. The formation of carbon nanoparticles in flames involves a complex interplay of physical and chemical processes. It is known to depend on the fuel composition, the flame structure, and the presence of aromatic species contributing to the carbon yield. We present a study of the flexoelectric interaction between fullerene-like polar aromatics and chemi-ions in a flame. We imaged the nascent carbon particles in a flame using a transmission electron microscope. The majority of aromatics in the flame strongly interact with chemi-ions. The results indicate that the interaction between fullerene-like polar aromatics and chemi-ions is critically assisting the nucleation and opens a new route to reduce pollution and improve flame-produced nanoparticle synthesis.

HIGHLIGHTS

ARTICLE
 DOI: 10.1038/s41467-018-06269-z OPEN

Hydrogen spillover through Matryoshka-type (ZIFs@ZIFs)

OUTSTANDING WORK FROM THE LAST SIX MONTHS OF CAMBRIDGE CARES RESEARCH

REVIEW
 H₂O₂ Production

Selective Electrochemical H₂O₂ Production via Two-Electron Oxygen Electrochemistry

Yuanyuan Jiang, Pengjuan Ni, Chuanxia Chen, Yizhong Biao Kong, Adrian Fisher, and Xin Wang*

Direct electrochemical production of hydrogen peroxide (H₂O₂) through two-electron oxygen electrochemistry, for example, the oxygen reduction in fuel cells or water oxidation in water electrolyzers, could provide an attractive alternative to locally produce this chemical on demand. The efficiency of these processes depends greatly on the availability of cost-effective catalysts with high selectivity, activity, and stability. In recent years, various novel nanostructured materials have been reported to selectively produce H₂O₂. Through combined experimental and theoretical approaches, underlying mechanisms in the electrochemical and theoretical approaches, electrochemistry have been unveiled. Considering the remarkable progress in this area, the authors summarize recent developments regarding the direct production of H₂O₂ through two-electron electrochemical oxygen reactions. The fundamental aspects of electrochemical oxygen reactions are introduced. Various types of electrochemical oxygen reactions are first two-electron oxygen electrochemistry that can effectively produce H₂O₂ via unique structure-, component-, and composition-dependent electrochemical performance together with the underlying catalytic mechanisms are discussed. Finally, a brief conclusion about the recent progress achieved in electrochemical generation of H₂O₂ and an outlook on future research challenges are given.

Dr. Y. Y. Jiang, Dr. P. J. Ni, Dr. C. X. Chen, Prof. Y. Z. Lu, Prof. P. Yang
 School of Materials Science and Engineering
 University of Jinan
 Jinan 250022, P. R. China
 E-mail: mse_luyz@ujn.edu.cn
 Prof. B. Kong
 Department of Chemistry
 Shanghai University

the instability of H₂O₂ in acidic media. Therefore, there is increasing interest in low-cost and decentralized production of H₂O₂ to greatly reduce the cost of H₂O₂.

Near Real-Time Electrical Grids

Moirangthem, Member, IEEE
 and Amaratunga

economically, and in an environment-friendly manner. At a higher level of abstraction, even in a process of integrating renewable energy sources into the power system, the environmental power dispatch with all hydro power

can become "pro

Energy 150 (2018) 1039–1057
 Contents lists available at ScienceDirect
 Energy

homepage: www.elsevier.com/locate/energy

environmental power dispatch with all hydro power
 An A.J. Amaratunga^a, B.Y. Qu^b, Gehan A.J. Amaratunga^c
^aSingapore Technological University, Singapore
^bGuangdong University of Technology, China
^cShanghai University, China

ABSTRACT
 Economic-environmental power dispatch is one of the most popular bi-objective optimization problems in power system. Classical economic power dispatch problem thermal generators often ignoring security constraints of the network. But in modern power systems, environmental sustainability perspective and hydro power generation is paramount for environmental grid is encouraged. However, the intermittent and uncertain nature of renewable energy sources and hydro power sources are intermittent and uncertain. This paper proposes multi-objective power dispatch problem formulation and solution incorporating stochastic programming (run-of-river) power. Weibull, lognormal and Gumbel probability distributions are used to model the wind, solar and small-hydro power respectively. Some conventional IEEE 30-bus system are replaced with renewable power source and security constraints such as transmission line capacities and bus voltage constraints are considered. Decomposition based multiobjective evolutionary algorithm is used to solve the problem. Superiority of feasible solutions, is investigated using a multiobjective differential evolution algorithm. The simulated annealing algorithm is used to handle the constraints. The superiority of the proposed algorithm is summarized, analyzed and compared in this study.

power dispatch. However, due to the carbon tax imposition in market, the carbon tax exercised on controlling emissions is becoming increasingly important. The carbon tax is a market-based approach to reduce greenhouse gas emissions. It is a tax levied on the carbon content of fossil fuels. The carbon tax is a market-based approach to reduce greenhouse gas emissions. It is a tax levied on the carbon content of fossil fuels.

PhD student Vishvak Kannan discusses the real-world impact of using electrochemical systems to reduce carbon emissions

Sensitivity and uncertainty analysis of electrochemical systems to reduce carbon emissions

Boosting energy efficiency and switching to clean energy are non-negotiable parts of reducing global carbon emissions. At CARES, we are working on electrochemical and mathematical solutions to both of these requirements, with the aim of developing and optimising new technologies that will assist industry in its contribution towards global carbon reduction.

An electrochemical system uses a chemical reaction to produce electrical energy or vice versa. A few of the most well-used electrochemical systems include batteries, fuel cells, supercapacitors and electrochemical converters. These systems may either be galvanic—converting chemical energy to electrical energy, or electrolytic—using electrical energy to perform a chemical reaction. The energy efficiency of such systems is quantified as the amount of energy required to provide the current or the products. The operating conditions of such systems greatly affects the energy efficiency because the chemical changes are sensitive to the operating conditions such as temperature, pressure, active surface area of the catalyst, etc.

Sensitivity analysis is the study of how the uncertainty in the output of a mathematical model can be related to different uncertainties in the input to the model. A similar study that quantifies this uncertainty and predicts the propagation of un-

certainty is called uncertainty analysis. In other words, the sensitivity analysis shows how sensitive a system is to a given set of operating parameters and uncertainty analysis quantifies the deviation of the output of the system with respect to the deviations in operating parameters. In addition to predicting optimal working conditions of the system, these analyses also help to identify regions of failure and evaluate a new technology. Through this optimisation we can achieve better energy efficiencies.

Recent studies have reported sensitivity and uncertainty analysis of individual functional layers/components of these electrochemical systems (like the catalyst layer) or consider these systems as an energy source/sink of a larger network. However, there are very few or no studies on the sensitivity and uncertainty analyses of mechanistic models of these electrochemical systems mainly due to the computational cost.

At CARES, we are developing fast mechanistic models of a CO₂ converter, galvanic electrochemical reactor, electrochemical capacitor and lithium-ion battery to carry out these analyses. This will help to improve the energy efficiency of and to predict and evaluate future low-carbon technologies. These fast models allow us to reduce the computational cost significantly, which enables a mechanistic sensitivity and uncertainty analysis.

The work we are doing in this area is essential if Singapore is going to meet its Paris Agreement pledge to reduce emissions intensity by 36% below 2005 levels by 2030. In Singapore's Climate Action Plan, developed by the National Climate Change Secretariat, the introduction of a carbon tax will encourage industry to low their emissions. The ability to measure and improve the energy efficiency of low-carbon technologies will encourage their development and implementation, globally as well as in Singapore.

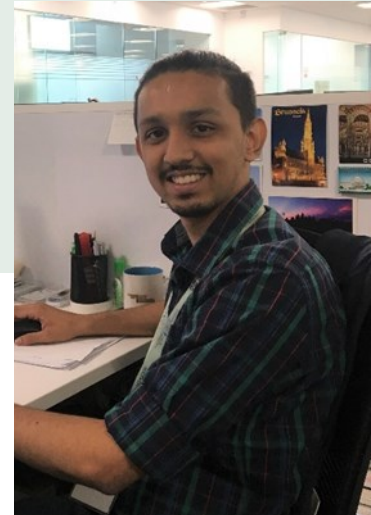

Vishvak Kannan (PhD student, NUS, IRP2) received his Bachelor of Technology in chemical engineering from Amrita School of Engineering, India. He is currently pursuing his PhD in chemical engineering with Cambridge CARES and National University of Singapore. During his undergraduate studies, he has worked on synthesis of metal oxide nanocomposites as electrodes for lithium-ion batteries and multiphase flow of immiscible liquids in small channels. His current area of research focuses on mathematical modelling of fundamental and applied electrochemical systems.

SINGAPORE'S CLIMATE ACTION PLAN

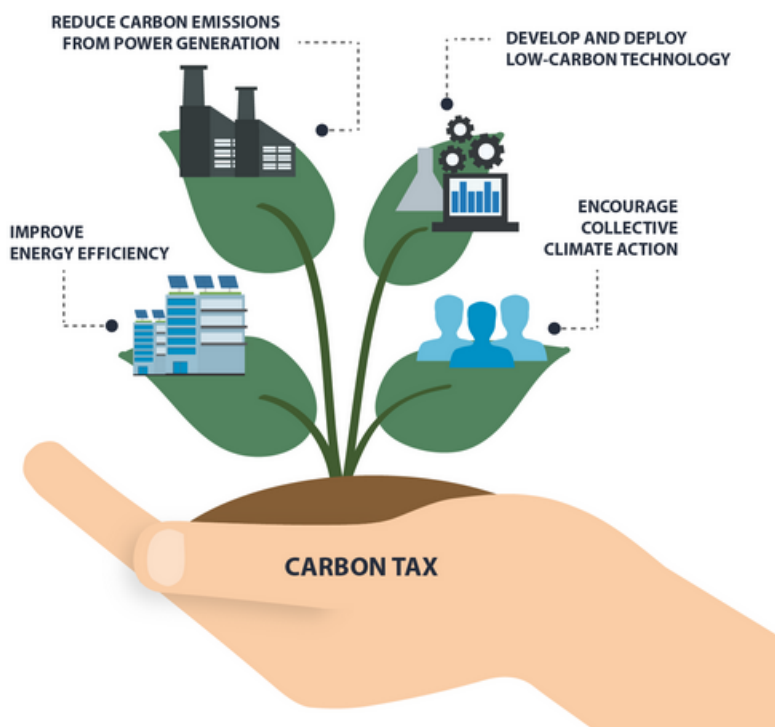

Image: National Climate Change Secretariat, Strategy Group, Prime Minister's Office.

FOCUS ON

FUNDAMENTAL SCIENCE

Researcher Dr YAN Yong explains the process of catalysis and how it can create useful products from excess CO₂

Catalytic CO₂ hydrogenation to compensate for carbon emissions

The idea of catalysis was first employed by Swedish chemist Jöns Jacob Berzelius in 1835, and referred to the increase in reaction rate by the addition of catalysts. A catalyst will participate in a reaction but not be consumed during the process. Heterogeneous catalysis is distinguished by the use of catalysts in a different phase from the reactants and products and is excellent for product separation and the recycling of catalysts. As one of the most successful applications of heterogeneous catalysis in the 20th century, the three-way catalytic converter for the gasoline engine exhaust-gas treatment achieves the simultaneous reduction in the emission of CO, unburned hydrocarbons (HC) and nitric oxides (NO_x).

The superiority of this technology is obvious—three-way catalytic converters can significantly reduce the hazardous content of automobile emissions; ~95% of fatal CO, ~80% of unburned HC, the precursor of photo-chemical smog and ~85% of NO_x, which causes haze and acid rain. However, for the three-way catalytic converter to work effectively, extra fuel has to be consumed com-



Dr YAN Yong (Research Fellow, NTU, IRP1) received his doctorate in chemical engineering from Nanyang Technological University, Singapore and his Master's degree in environmental engineering from the Chinese Academy of Sciences, Beijing, China. His research interests lie in heterogeneous catalysis for CO₂ hydrogenation and oxygen carriers for chemical looping processes.

pared to the lean-burn engine, which leads to a 10% increase in CO₂ (carbon dioxide) emissions. CO₂, although considered less poisonous than the former three pollutants, is now attracting more attention than ever for its harmful environmental impacts.

The atmospheric concentration of CO₂ has been drastically rising since the Industrial Revolution, due to the vast consumption of fossil fuels. Human activities have resulted in an increase of 40% in atmospheric CO₂ over the last few decades. The enhanced concentration of atmospheric CO₂ not only results in a direct global warming effect, but also deteriorates the stability of the thermohaline circulation of the North Atlantic Ocean, increasing the

acidity of oceanic water and so on. All of these constitute delicate parts in the worldwide ecosystem and the failure of one component will eventually lead to the devastating collapse of the whole system. An immediate mitigation of CO₂ emissions is the only solution in preventing us reaching this tipping point.

Converting CO₂ into valuable products provides solutions for both the decrease of CO₂ concentration in emissions and the effective conversion of CO₂ after the fixation from the atmosphere. However, considering the reactant CO₂ is characterised by high thermodynamic stability, a selective catalytic reaction is needed to allow for an economic application. The catalytic hydrogenation of CO₂ shows great promise since large-scale H₂ production is expected to be available at a low cost by photocatalytic water splitting. Depending on the reaction conditions, the target products from CO₂ hydrogenation include methane, carbon monoxide, methanol, formic acid, dimethyl ether and ethanol.

After decades of dedicated endeavours from brilliant researchers, effective catalytic reaction systems have been developed and several industry projects are now ongoing. The first industrial-scale natural gas production by power-to-gas technology from CO₂ and renewable electricity is built by the Audi e-gas facility in Werlte, northern Germany. Carbon Recycling International in Iceland produces renewable methanol from catalytic CO₂ hydrogenation at 4 million litres per year for fuel applications and green production. The efforts in catalytic utilisation of CO₂ will continue to pay off to create a sustainable living environment for human beings.



Highlighted research outputs from May - October 2018

IRP1: Hydrogen spillover through Matryoshka-type (ZIFs@)_{n-1}ZIFs nanocubesGuowu Zhan and Hua Chun Zeng, *Nature Communications*

DOI: 10.1038/s41467-018-06269-z

Abstract: Hydrogen spillover phenomenon is well-documented in hydrogenation catalysis but still highly disputed in hydrogen storage. Until now, the existence of hydrogen spillover through metal-organic frameworks (MOFs) remains a topic of ongoing debate and how far the split hydrogen atoms diffuse in such materials is unknown. Herein we provide experimental evidence of the occurrence of hydrogen spillover in microporous

MOFs at elevated temperatures, and the penetration depths of atomic hydrogen were measured quantitatively. We have made Matryoshka-type (ZIFs@)_{n-1}ZIFs (where ZIFs = ZIF-8 or ZIF-67) nanocubes, together with Pt nanoparticles loaded on their external surfaces to produce atomic hydrogen. Within the (ZIFs@)_{n-1}ZIFs, the ZIF-8 shell served as a ruler to measure the travelling distance of H atoms while the ZIF-67 core as a terminator of H atoms. In addition to the hydrogenolysis at normal pressure, CO₂ hydrogenation can also trace the migration of H atoms over the ZIF-8 at high pressure.

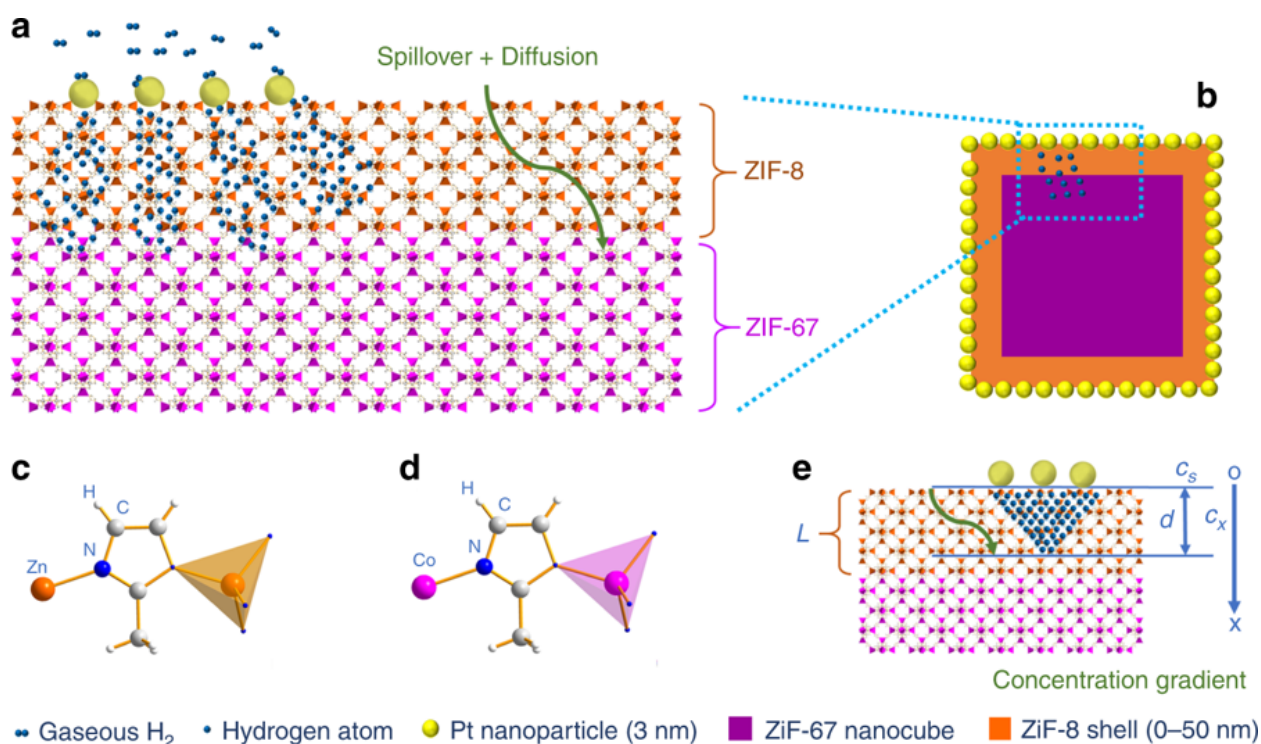

Schematic representation for the hydrogen spillover over ZIF-8. **a** The proposed pathway of hydrogen spillover in ZIF-8, which includes dissociative chemisorption of H₂ on Pt surface, and subsequent migration of H atoms onto ZIF-8 via spillover and diffusion, finally, hydrogenolysis of ZIF-67 if H atoms arrive the ZIF-67 layer. **b** ZIF-67@ZIF-8/Pt model catalyst in a cross-section view. **c**, **d** The Zn-Melm-Zn and Co-Melm-Co linkages the periodic ZIF-8 and ZIF-67 crystals, where the coloured tetrahedrons represent primary building units in ZIFs. **e** Schematic of concentration gradient of hydrogen atoms and the coordinate system of the model discussed in the main text, where *L* is the shell thickness of ZIF-8, and *d* is the penetration depth of hydrogen atoms.

IRP1: Ru/Al₂O₃ catalyzed CO₂ hydrogenation: Oxygen-exchange on metal-support interfaces

Yong Yan, Qiaojuan Wang, Chunyang Jiang, Yao Yao, Di Lu, Jianwei Zheng, Yihu Dai, Hongming Wang and Yanhui Yang, *Journal of Catalysis*

DOI: 10.1016/j.jcat.2018.08.026

Abstract: The metal-support interfaces of metallic nanoparticles supported on oxide surfaces determine the activated dissociation of CO₂ in CO₂ hydrogenation. It also guides the catalytic pathway towards either CO₂ methanation or reverse water-gas shift (rWGS). In this work, Ru/Al₂O₃ catalysts with different Ru structural configurations were prepared by controlling the Ru weight loadings, which revealed the structure-dependence of production rates for CO and CH₄ formation with different apparent activation energies. Based on the characterisation results, two catalyst models were setup: the Ru₉/Al₂O₃ model consisted of an interface of monolayer Ru sites tightly contacted with γ -Al₂O₃ support, and the Ru₃₅/Al₂O₃ model represented a relatively larger Ru nanocluster supported on γ -Al₂O₃. Theoretical calculations of

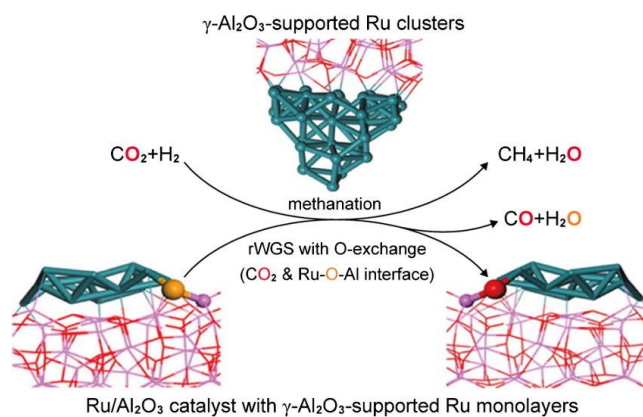

these two models demonstrated that monolayer Ru sites favored the rWGS route with a relatively low energy barrier for both CO₂ activation and CO formation steps, while Ru nanoclusters preferred the methanation route energetically. Furthermore, the combination of theoretical calculations and experimental isotope-exchange measurements suggested that the interfacial O species in Ru-O-Al interfaces played a critical role in CO₂ activation via oxygen-exchanging with the O atom in the feeding CO₂ and consequently incorporation into the final hydrogenation product.

IRP1: Explicit Flue Gas Adsorption Isotherm Model for Zeolite 13X Incorporating Enhancement of Nitrogen Loading by Adsorbed Carbon Dioxide and Multi-Site Affinity Shielding of Coadsorbate Dependent upon Water Vapor Content

Mark Purdue, *The Journal of Physical Chemistry C*

DOI: 10.1021/acs.jpcc.8b02071

Abstract: Carbon capture from flue gas by adsorption processes requires a suitable isotherm model for use in process simulators. Comparative physical adsorption isotherm models are here tested on an adsorption equilibrium loading data set for Zeolite 13X (Z13X) between 298 and 348 K. Dry flue gas mixture adsorption was found to involve enhanced adsorption of N₂ by up to 85% relative to levels of N₂ mixture adsorption predicted with pure species parameters. This relative N₂ deviation was found strongly dependent upon the amount of adsorbed CO₂ and suggested to be caused by optimisation of molecular quadrupole interactions in the adsorbate layer. A supplemental isotherm expression dependent upon mixture fitting parameters characterised the phenomenon. Prediction of wet flue gas mixture adsorp-

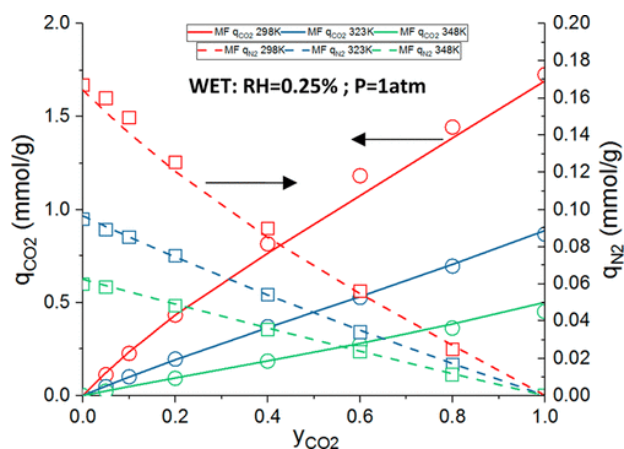

tion on Z13X was tested with different numbers of adsorption sites in the α -cavity and logistic formulations to exclude CO₂ and N₂ from hydrophilic adsorption sites but without success. Shielding the affinity of Z13X toward coadsorbates using the moisture content in the gas mixture improved regression residuals. This method of sticking parameter adjustment described the influence of adsorbed H₂O hydrogen-bonded clusters on CO₂ and N₂ and may provide a path to humid mixture adsorption prediction through studies of pure H₂O in porous materials.

IRP2: Selective electrochemical H_2O_2 production through two-electron oxygen electrochemistry

Yuanyuan Jiang, Pengjuan Ni, Chuanxia Chen, Yizhong Lu, Ping Yang, Biao Kong, Adrian Fisher and Xin Wang, *Advanced Energy Materials*

DOI: 10.1002/aenm.201801909

Direct electrochemical production of hydrogen peroxide (H_2O_2) through two-electron oxygen electrochemistry, for example, the oxygen reduction in fuel cells or water oxidation in water electrolyzers, could provide an attractive alternative to locally produce this chemical on demand. The efficiency of these processes depends greatly on the availability of cost-effective catalysts with high selectivity, activity, and stability. In recent years, various novel nanostructured materials have been reported to selectively produce H_2O_2 . Through combined experimental and theoretical approaches, underlying mechanisms in the electrochemical synthesis of H_2O_2 via oxygen electrochemistry have been unveiled. Considering the remarkable progress in this area, the authors summarise recent developments regarding the direct production of H_2O_2 through two-electron electrochemical oxygen reactions. The fundamental aspects of electrochemical oxygen reactions are first introduced. Various types of catalysts that can effectively produce H_2O_2 via two-electron oxygen electrochemistry are then presented. In parallel, the unique structure-, component-, and

IRP2: Design and Integration of Molecular-Type Catalysts in Fuel-Cell Technology

Vishal Jose, Kamal Elouarzaki, Adrian Fisher and Jong-Min Lee, *Small Methods*

DOI: 10.1002/smt.201800059

The field of molecular electrocatalysis research includes a wide range of emerging technologies that utilise molecular catalysts to catalyse anodic and/or cathodic reactions within a fuel-cell setup, and has developed greatly in the last 10 years. Although the vast majority of fuel cells utilise noble metals as catalysts, several systems have been recently developed that are based on molecular catalysts. The focus here is on the integration of molecular catalysts in a fuel-cell setup, which is contextualised, and which is named as “fuel-cell-

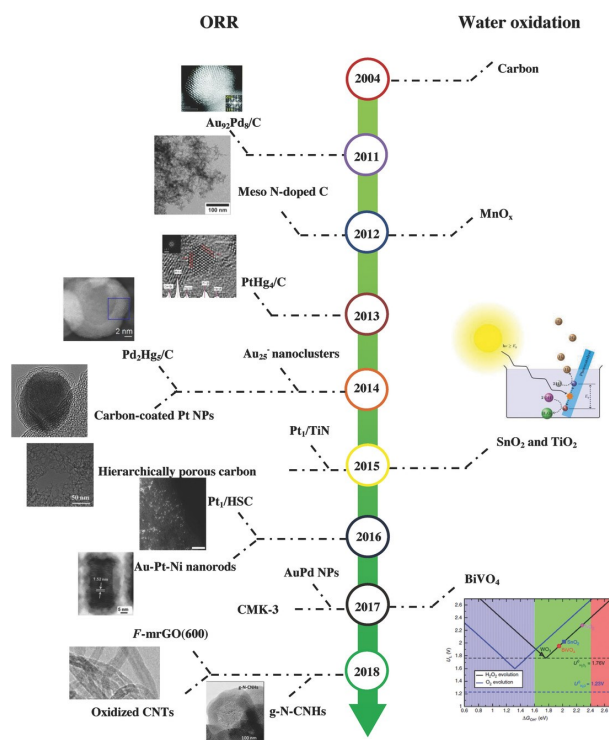

A brief summary of some important findings of H_2O_2 production through two-electron oxygen electrochemistry.

composition-dependent electrochemical performance together with the underlying catalytic mechanisms are discussed. Finally, a brief conclusion about the recent progress achieved in electrochemical generation of H_2O_2 and an outlook on future research challenges are given.

based molecular-type catalysts” here. The latter utilise a wide variety of chemical compounds, such as organometallics and organic or bio-inspired compounds, to harvest chemical energy to generate current. Here, the state-of-the-art for all molecular catalysts that convert chemical energy in a fuel-cell setup is discussed and a novel classification system is presented to illustrate how molecular catalysts integrate into the broad field of fuel cells. The current performance of molecular catalysts in systems that use different fuels is summarised, and finally, for the first time, the achievable power outputs of fuel cells using uniquely molecular catalysts are presented.

Glucose fuel-cell MAE
reported by Elouarzaki et al.

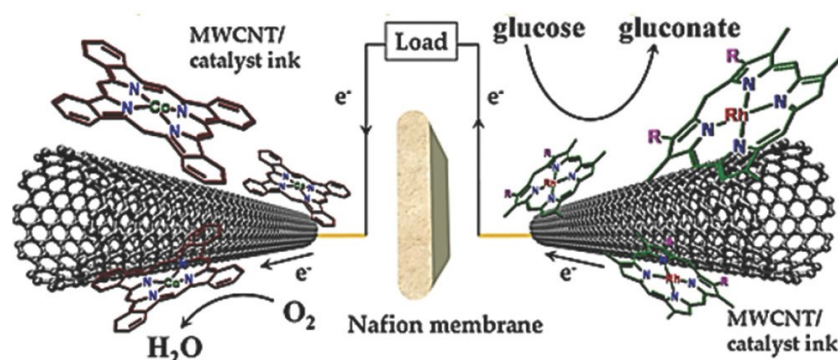

IRP2: Coupling orientation and mediation strategies for efficient electron transfer in hybrid biofuel cells

Kamal Elouarzaki, Daojian Cheng, Adrian Fisher and Jong-Min Lee, *Nature Energy*

DOI: 10.1038/s41560-018-0166-4

Abstract: Enzymes are promising electrocatalysts for electron transfer (ET) in many biological processes. Strategies to enhance ET between enzymes and electroactive surfaces include orientation and immobilisation of the enzymes and electron mediation. Here, we develop a strategy to couple orientation and electron mediation on electrodes based on carbon nanotubes. This is achieved by the synthesis of a redox mediator that contains an enzyme-orientation site (pyrene), an electron-

carrier redox mediator (2,2'-azino-bis(3-ethylbenzthiazoline-6-sulfonic acid) (ABTS)) and an electropolymerisable monomer (pyrrole). The coupling of an enzymatic orientation and a mediated ET in the same chemical structure (pyrrole-ABTS-pyrene (pyrr-ABTS-pyr)) provides a much-improved performance in the bioelectrocatalysis. We demonstrate two fuel cells for the synthesised redox mediator. In a proton-exchange membrane hydrogen/air fuel cell and in a membraneless fuel cell, the pyrr-ABTS-pyr biocathode provides a power density of 1.07 mW cm^{-2} and 7.9 mW cm^{-2} , respectively. The principle of coupling an enzyme orientation and a redox mediator allows a great variety of mediators to be engineered and provides vast possibilities for the development of fuel cells.

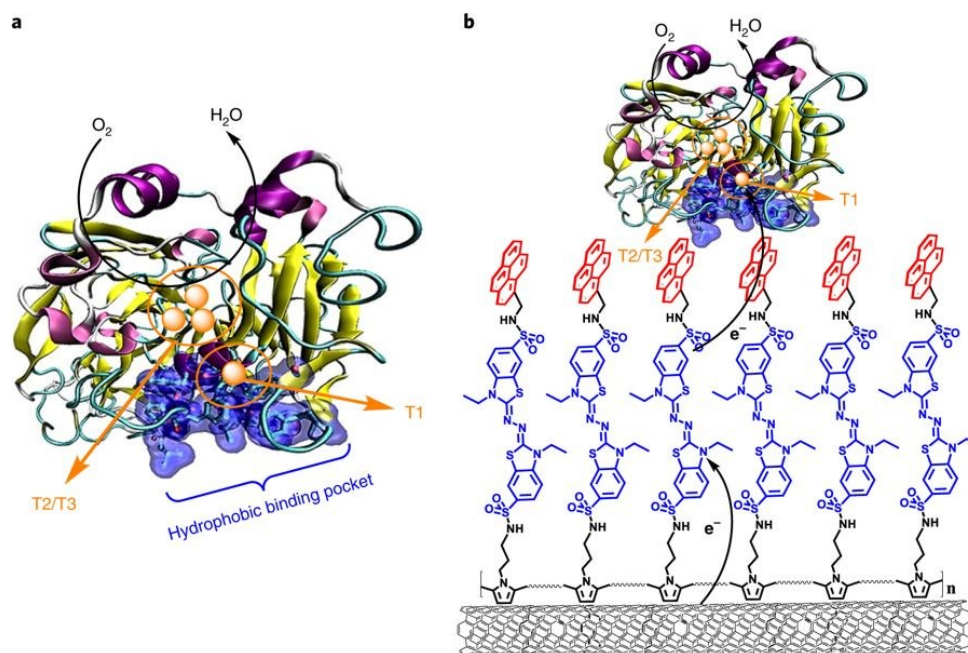

a Representations of *Trametes versicolor* Lac with the hydrophobic binding pocket oriented towards the bottom of the page and the T1 copper site located on one side of the enzyme at the base of a hydrophobic pocket, which acts as the binding site of the enzyme substrate. **b** Graphical depiction of the ET from the electrode towards Lac through poly(pyrr)-ABTS-pyr film.

IRP3: Flexoelectricity and the Formation of Carbon Nanoparticles in Flames

Jacob Martin, Maria Botero, Radomir Slavchov, Kimberly Bowal, Jethro Akroyd, Sebastian Mosbach and Markus Kraft, *The Journal of Physical Chemistry C*

DOI: 10.1021/acs.jpcc.8b08264

Abstract: The formation of carbon nanoparticles in flames involves a nucleation step that remains poorly understood. Experimentally, carbon nuclei formation is known to depend strongly on the electrical aspects of combustion, but modes of interaction between charged species in the flame and carbon precursors have yet to be found. We present evidence for flexoelectrically polarised

aromatics contributing to carbon nanoparticle nucleation. We imaged the nascent nanoparticles using high resolution transmission electron microscopy, which revealed that the majority of aromatics in the early carbon nanoparticles are fullerene-like and curved. The curvature induces a significant molecular flexoelectric dipole moment in the polyaromatic hydrocarbons. This electric polarisation allows these molecules to strongly interact with chemi-ions produced during combustion, which we demonstrate using electronic structure calculations. The results indicate that the physical interaction between fullerene-like polar aromatics and chemi-ions is critically assisting the nucleation and opens a new route to reduce pollution and improve flame-produced nanomaterials.

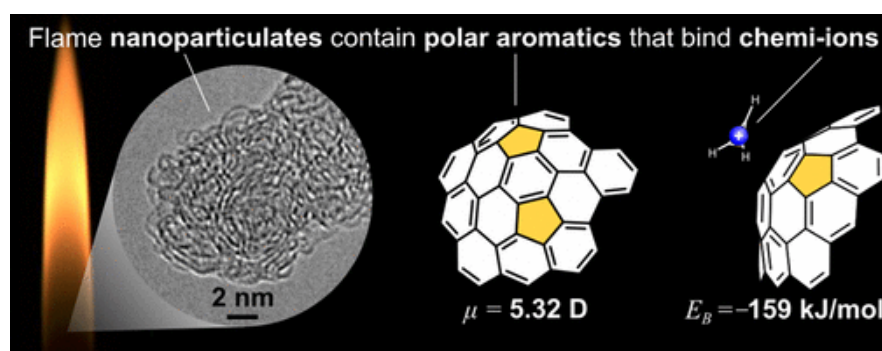

IRP3: Amino-Assisted Anchoring of CsPbBr₃ Perovskite Quantum Dots on Porous g-C₃N₄ for Enhanced Photocatalytic CO₂ Reduction

Man Ou, Wenguang Tu, Shengming Yin, Weinan Xing, Shuyang Wu, Haojing Wang, Shipeng Wan Qin Zhong and Rong Xu, *Angewandte Chemie International Edition*

DOI: 10.1002/anie.201808930

Abstract: Halide perovskite quantum dots (QDs) have great potential in photocatalytic applications if their low charge transportation efficiency and chemical instability can be overcome. To circumvent these obstacles, we anchored CsPbBr₃ QDs (CPB) on NH_x-rich porous g-C₃N₄ nanosheets (PCN) to construct the composite photocatalysts via N-Br chemical bonding. The 20 CPB-PCN (20 wt % of QDs) photocatalyst exhibits good stability and an outstanding yield of 149 μmol h⁻¹ g⁻¹ in acetonitrile/water for photocatalytic reduction of CO₂ to CO under visible light irradiation, which is around 15 times higher

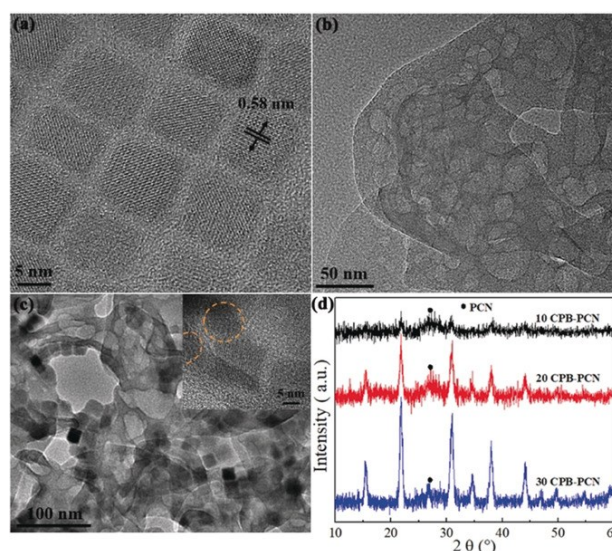

TEM image of a) CsPbBr₃ QDs, b) PCN, c) 20 CPB-PCN, and d) XRD patterns of CPB-PCN photocatalysts with different content of QDs.

than that of CsPbBr₃ QDs. This study opens up new possibilities of using halide perovskite QDs for photocatalytic application.

IRP3: Size spectra and source apportionment of fine particulates in tropical urban environment during southwest monsoon season

Yichen Zong, Maria Botero, Liya Yu and Markus Kraft, *Environmental Pollution*

DOI: 10.1016/j.envpol.2018.09.124

Abstract: In this study, we carried out high time-resolution measurements of particle number concentration and size distribution (5–1000 nm) in Singapore, which represents a tropical urban environment. The measurements were taken during the southwest monsoon season in 2017 using a fast-response differential mobility spectrometer at a sampling rate of 1 Hz. In the measurement, short-lived nucleation events were found prominent at early afternoon because of the abundant

incoming radiation that enhances the photochemical reactions in atmosphere. For the first time in the region, a five-factor positive matrix factorisation approach was applied to the size spectra data. Based on PM number concentration, two sources within nucleation mode (<30 nm) were resolved and account for 43% of total number concentration, which is higher than the available monitoring data in other big cities. Among the sources, O₃-related atmospheric photochemical reactions with peak size at 10–12 nm is a unique factor and prominent in early afternoon nucleation events. The findings of this work can serve as a baseline for assessing influence of local and cross-border airborne PM emissions during various seasons in the future.

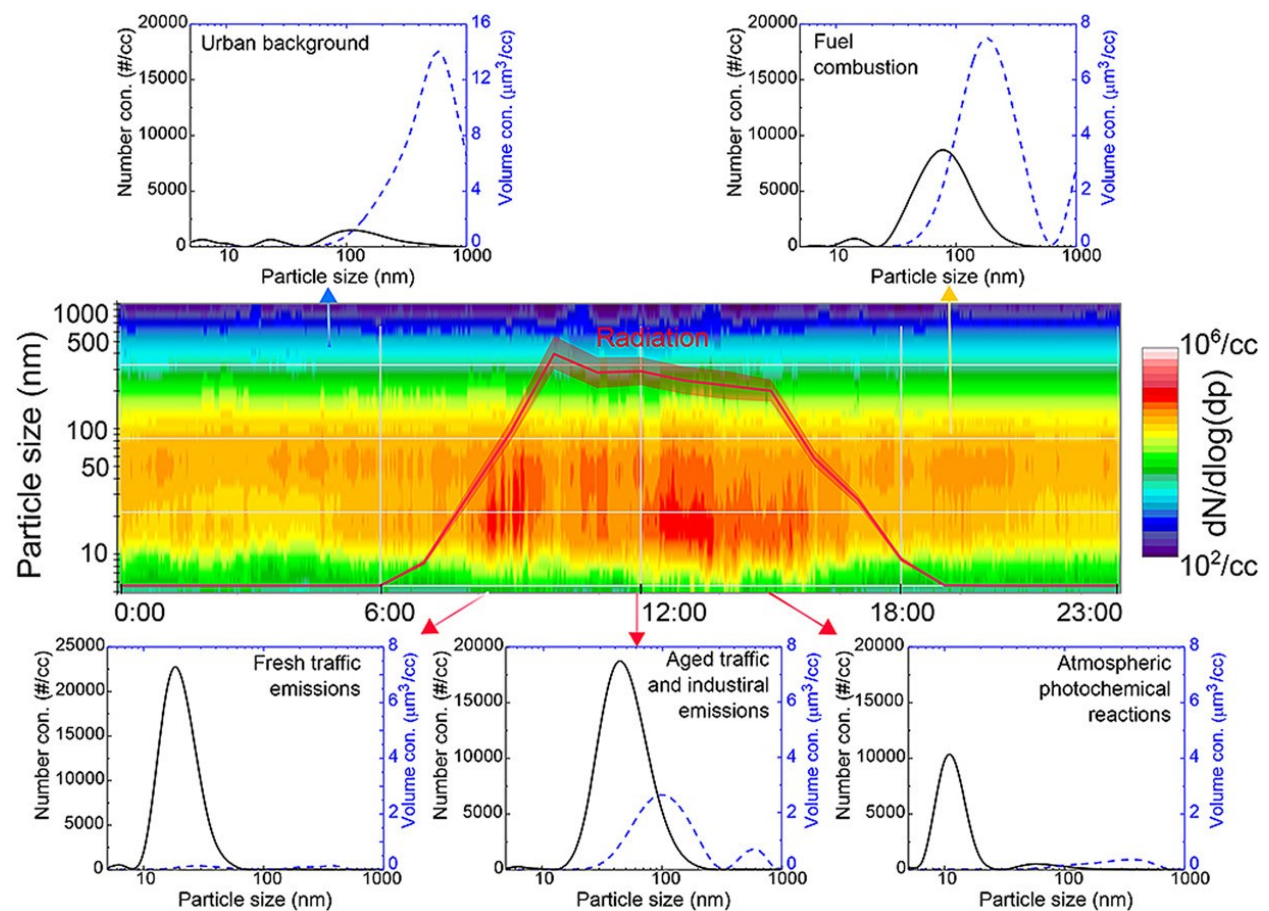

IRP4: Multi-objective economic-environmental power dispatch with stochastic wind-solar-small hydro power

Partha Biswas, P.N. Suganthan, Boyang Qu and Gehan Amarantunga, *Energy*

DOI: 10.1016/j.energy.2018.03.002

Abstract: Economic-environmental power dispatch is one of the most popular bi-objective non-linear optimisation problems in power system. Classical economic power dispatch problem is formulated with only thermal generators often ignoring security constraints of the network. But importance of reduction in emission is paramount from environmental sustainability perspective and hence penetration of more and more renewable sources into the electrical grid is encouraged. However, most common forms of renewable sources are intermittent and uncertain. This paper proposes multiobjective economic emission power dispatch problem formulation and solution incorporating stochastic wind, solar and small-hydro (run-of-river) power. Weibull, lognormal and Gumbel probability density functions are used to calculate available wind, solar and small-hydro power respectively. Some conventional generators of the standard IEEE 30-bus system are replaced with renewable power sources for study purpose. Network security constraints such as transmission line capacities and bus voltage limits

IRP4: GIS integrated automation of a near real-time power-flow service for electrical grids

Krishnanand Kaippilly Radhakrishnan, Joymala Moirangthem, Sanjib Kumar Panda and Gehan Amarantunga, *IEEE Transactions on Industry Applications*

DOI: 10.1109/TIA.2018.2855645

Abstract: Electrical grid's modernisation and the need for sustainable sources of energy lead to changes in physical infrastructure and subsequent operations of the grid, such as penetration of renewables and local power generation from them. There is a shift in paradigm from remotely concentrated generation towards distributed generations that are local to the loads. To meet the objective of sustainability, the local generations must include renewable energy conversions. This requires power-flow management of power varia-

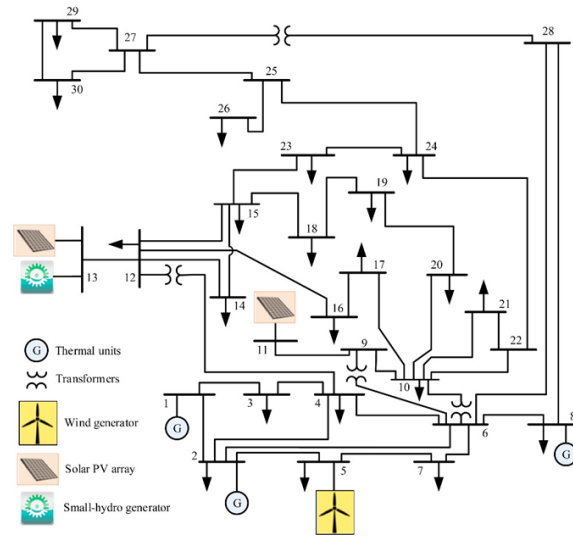

Adapted IEEE 30-bus system for MOEED study with wind-solar-small hydro units.

are also taken into consideration along with constraints on generator capabilities and prohibited operating zones for the thermal units. Decomposition based multiobjective evolutionary algorithm and summation based multiobjective differential evolution algorithm are applied to the problem under study. An advanced constraint handling technique, superiority of feasible solutions, is integrated with both the multiobjective algorithms to comply with system constraints. The simulation results of both the algorithms are summarised, analysed and compared in this study.

bility arising from the spatial and temporal characteristics of the renewables like solar energy. Such management must require least human intervention, and it is achievable through fast and reliable automations. This paper presents Geographic Information System (GIS) integrated automation of a non-iterative power-flow method known as Holomorphic Embedded Power Flow (HEPF), thereby providing local grids the ability to manage themselves. Since HEPF reliably guarantees the solution and reaches it very fast through constructing the solution, it is an ideal candidate for near real-time updates of the electrical states of a power system. The role of the HEPF as a key enabler for the services of a power-flow manager, that performs optimisations for a cluster of buildings, is then illustrated.

Accompanying figure >

IRP4: A trust-region based sequential linear programming approach for AC optimal power flow problems

L.P.M.I. Sampath, Bhagyesh Vijay Patil, Hoay Beng Gooi, Jan Maciejowski and Keck-Voon Ling, *Electric Power Systems Research*

DOI: 10.1016/j.epsr.2018.09.002

Abstract: This study proposes a new trust-region based sequential linear programming algorithm to solve the AC optimal power flow (OPF) problem. The OPF problem is solved by linearising the cost function, power balance and engineering constraints of the system, followed by a trust-region to control the validity of the linear model. To alleviate the problems associated with the infeasibilities of a linear approximation, a feasibility restoration phase is introduced. This phase uses the original nonlinear constraints to quickly locate a feasible point when the linear approximation is infeasible. The algorithm follows convergence criteria to satisfy the first order optimality conditions for the original OPF problem. Studies on standard IEEE systems and large-scale Polish systems show an acceptable quality of convergence to a set of best-known solutions and a substantial improvement in computational time, with linear scaling proportional to the network size.

tems show an acceptable quality of convergence to a set of best-known solutions and a substantial improvement in computational time, with linear scaling proportional to the network size.

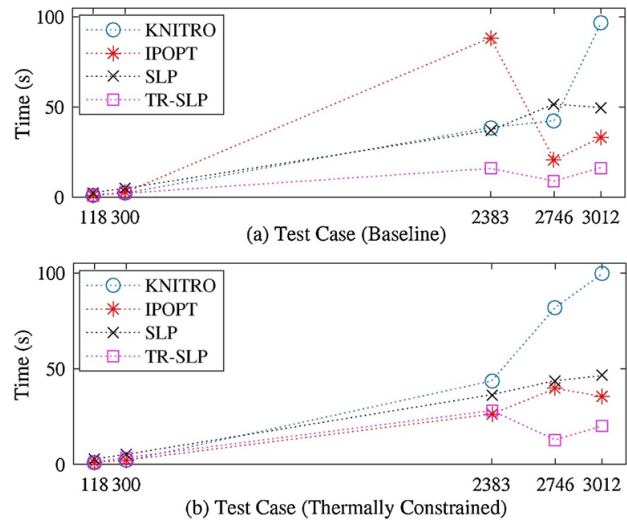

The computational scalability comparison among all solvers/algorithms for various IEEE (118, 300) and Polish (2383, 2746, 3012) systems.

This shows the schematic of SCU server and client real-time communication that integrates HEPF-based power flows and its optimisations to an updatable GIS display. Since the GIS here is displayed in browsers, many of the modern smart display devices can utilise the services of SCU. This could provide intuitive understanding to microgrid managers or building operators to perform prosumer side management.

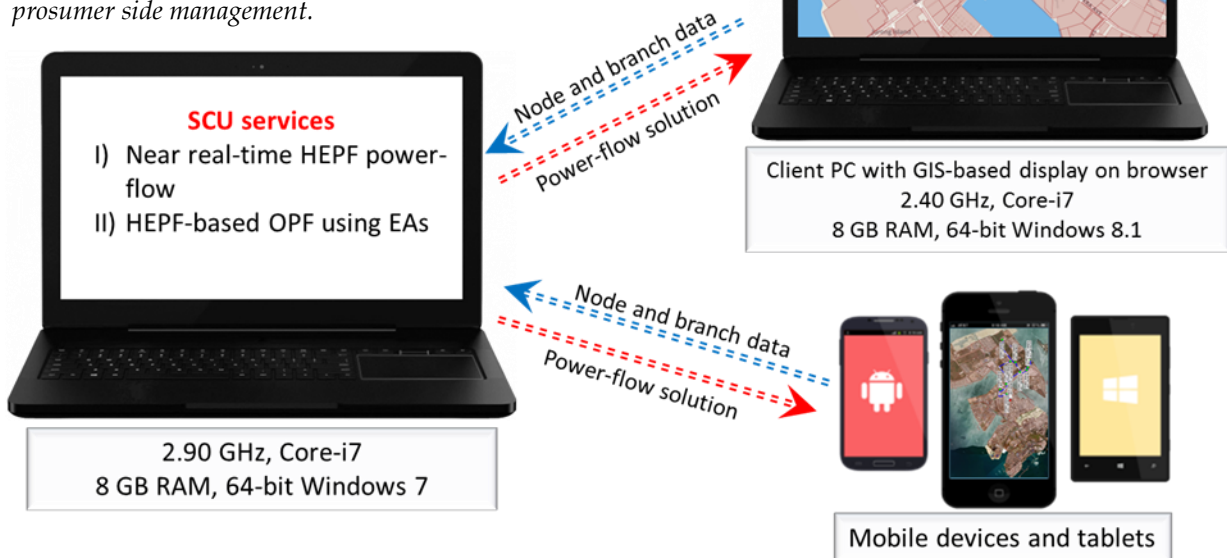



Perna Goyal (PhD student, NUS, IRP1) works on the Vacuum Swing Adsorption pilot plant rig.



IRP1: MUSCAT

MULTI-SCALE STUDIES OF CATALYTIC AND ADSORPTION TECHNOLOGIES (MUSCAT)

MUSCAT seeks to extend existing expertise in reaction engineering, multi-scale imaging and modelling to reduce the carbon footprint and energy demand of existing chemical processes by making catalytic and separation processes more efficient as well as by introducing enhanced CO₂ capture strategies into existing processes. The aim is to tackle a range of problems relevant to industry in Singapore and to investigate solutions with the potential to have short- and long-term deliverables that improve the economic and environmental performance of both existing and new processes.

MUSCAT is led by PIs:

Prof. Alexei Lapkin (CAM)

Prof. Samir Mushrif (NTU)

Prof. Hua Chun ZENG (NUS)



OVERVIEW

In the latest reporting period, significant advances in our core research areas have been achieved.

Most projects within IRP1 are maturing towards important milestones, such as patent applications, final papers and the generation of new proposals based on discoveries made during the project and new hypotheses. In the area of bio-feedstocks conversion, the team, comprising researchers from NTU and Cambridge, has completed the study on the mechanism of glycerol hydrogenolysis and the publication is being finalised. There are a number of exciting new functional structured materials emerging from the group of Prof. Hua Chun ZENG (PI, NUS) and in the collaboration with Cambridge we have found a way of scaling up synthesis of some of these materials. One patent has been filed for the process and materials and a second filing is currently being prepared. In this area IRP1 is now exploring potential new collaborations, including with A*STAR institutes.

The work on CO₂ capture has progressed significantly over the last few months, with the final commissioning of the pilot scale rig. The team is now generating data and finalising their publications on the new carbon capture cycle.

The final stage of Phase 1 within IRP1 has seen the start of new projects, such as the work on paper industry waste conversion to bulk intermediates, significant investment into research infrastructure in preparation for Phase 2, such as development of high-pressure catalytic rig for methanol synthesis and commissioning of the parallel reactor catalytic testing rig, as well as ongoing work in the key scientific areas of IRP1: development of catalysts for CO₂ and methane conversion, and further work on carbon capture. At the same time we have begun work on the project co-funded by industry, in the area of process optimisation by machine learning methods and have signed a new industrial contract to work on new methods of developing bio-based reactions.

Prof. Alexei Lapkin, PI
University of Cambridge

Update on work package 2.1

Chemical looping with advanced oxide carriers

For the last six months, Jijiang HUANG (PhD student, NTU) has continued his work on the development of high-performance Ni catalysts for dry reforming of methane reaction. The catalysts were prepared via calcination of NiMgAl layered double hydroxides precursors. After H₂ treatment, highly-dispersed Ni particles formed on the MgO/Al₂O₃ oxides support (Figure 1.1), achieving CH₄ conversion rate as high as 8.3 mmol_{CH₄} g_{catalyst}⁻¹ s⁻¹ at 900 °C. It was also found that higher Mg/Al ratio in the support enhanced the stability of the catalysts.

Nicholas Jose's (PhD student, CAM) recent work has been focused on the synthesis of two-dimensional materials and their applications. The high shear microreactor developed previously has recently been filed for provisional patent status. Figure 1.2 is an artistic representation of the reactor and its ability to influence the assembly of two-dimensional layered double hydroxides.

Studies of metal organic frameworks (MOFs) in the microreactor have also yielded interesting results. Recent experiments with Cambridge University's liquid transmission electron microscope holder have shown that microreactor synthesis and solvent selection can access new polymorphs and architectures of 2D MOFs.

Work in the next phase will focus on developing a commercial-scale platform for the rapid development of nanomaterials, with applications in energy, pharmaceuticals and chemical catalysis. Initial experiments to apply these 2D materials for supercapacitor electrodes have already had promising results, indicating commercial potential for this technology in the energy storage field.

Xiaoping CHEN's (Research Assistant, NTU) research focus is the non-oxidative coupling of methane over boron doped copper catalyst. He studied the effect of feeding gas flow rate, reaction

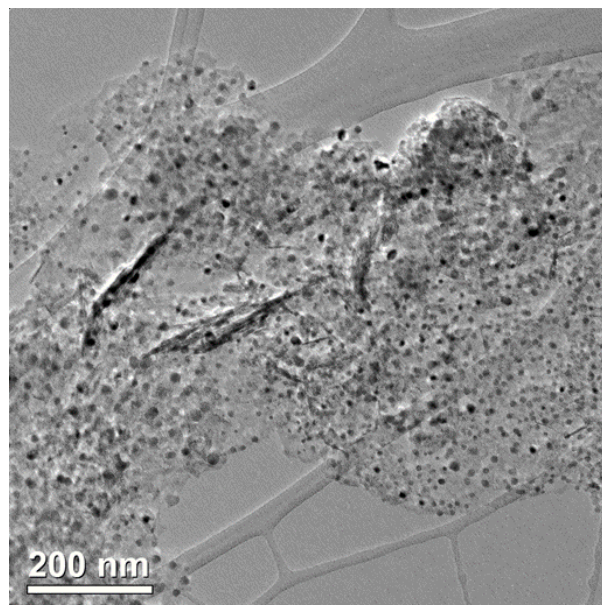

Fig. 1.1: TEM image of the highly-dispersed Ni particles supported on the MgO/Al₂O₃ oxides

Jijiang HUANG

Image credit: Dr YAN Yong

temperature, boron amount. He also studied the blank reaction with SiO₂ support only and reaction assisted with thermal cracking only. The catalyst stability test is also present to show how the catalyst work in a range of 200 mins. It was found that among all the parameters, flow rate, temperature are two main driving forces for methane conversion and C₂ yield. Adding of boron into copper slightly increases the yield of acetylene and methane conversion. However, a strong evidence for the effect of boron into copper on methane coupling is not yet found through the experiments.

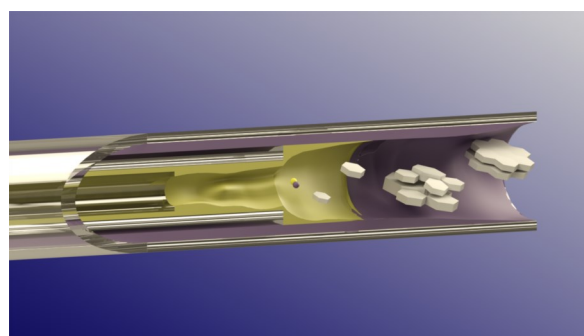

Fig. 1.2: High shear microreactor for chemical synthesis.

Nicholas Jose

Update on work package 1.2

CO₂ methanation and biomass conversion

In this reporting period, JIA Chunmiao (PhD student, NTU) has mainly worked on the catalyst research for CO₂ methanation in a fluidised bed, including the catalyst design, preparation and performance test (Figure 1.3). She is also working on process optimisation and catalyst characterisation.

In this reporting period, Dr Polina Yaseneva (Research Fellow, CAM) and her colleagues explored the production possibilities of the valuable platform molecule nopinone from two alternative terpenes-based waste feedstocks from paper production: crude sulfate turpentine (CST) from the Kraft process and pressate from the hot water process (HWP). Both feedstocks contain a mixture of terpenes (including terpene of interest b-pinene) but in different compositions. They modelled in Aspen Plus five different scenarios of nopinone production from waste feedstocks (Figure 1.4) via recombination of process steps: ozonolysis and distillation. Feedstock terpenes mixture (CST or HWP) is either oxidised and then the product of interest is separated or b-pinene is first separated and then oxidised to nopinone. The mass and energy flows obtained in Aspen models are used as inputs for LCA models and transferred to Umberto software, where environmental impacts as well as process costs are calcu-

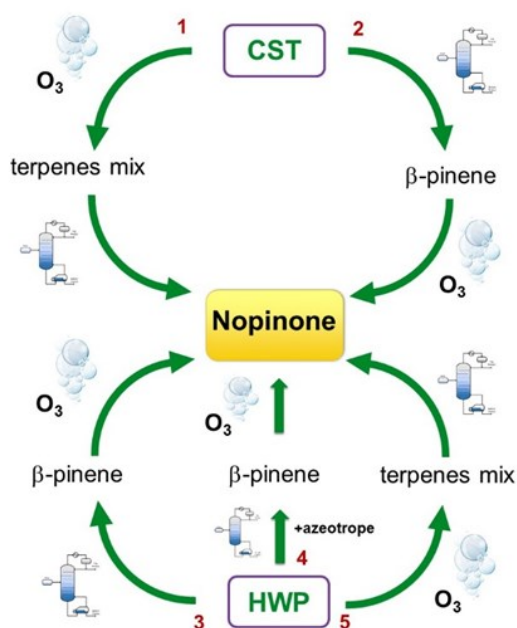
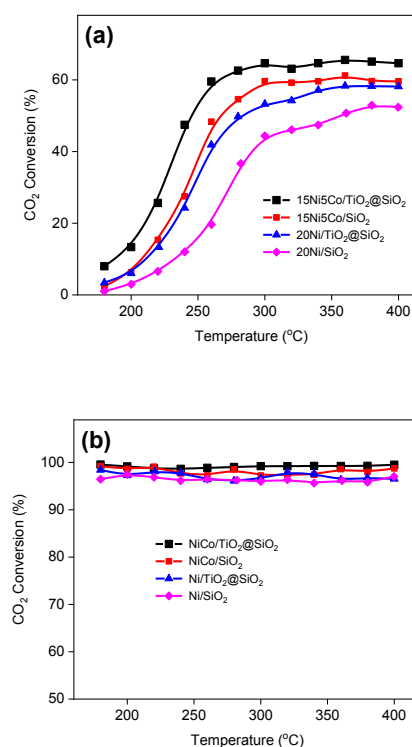

Fig. 1.3: The fluidised bed activity test: (a) CO₂ conversion, CH₄ selectivity. (b) Stability test of NiCo/TiO₂@SiO₂ at 260 °C with the H₂/CO₂ ratio of 4 under ambient pressure.

JIA Chunmiao



lated. Preliminary calculations of LCIA for scenarios 1 and 5 (direct ozonolysis of CST or HWP waste with following product separation) have shown that processing of HWP waste is significantly more benign (carbon footprint, human toxicity and acidification). It was also revealed that the main contributor to all environmental impacts calculated in both scenarios is the solvent used for mixture dilution – ethyl acetate – which overshadows all other contributions. Further Aspen model optimisation allowed reduction of the required amount of ethyl acetate and consequently the impacts. It is also planned to incorporate solvent recycling in order to further improve the processes.

Fig. 1.4: Scenarios for producing nopinone from low cost precursors.

Dr Polina Yaseneva

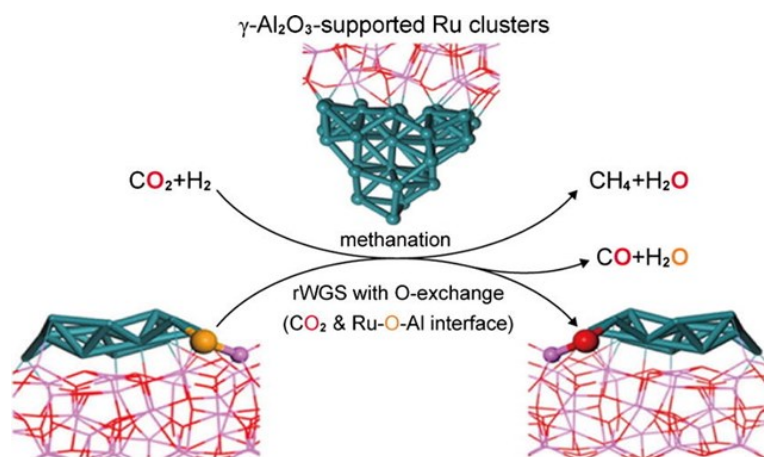

Fig. 1.5: Ru/Al₂O₃ catalyst with gamma-Al₂O₃-supported Ru monolayers for CO₂ methanation.

Dr YAN Yong

Dr YAN Yong (Research Fellow, NTU) reports that the metal-support interfaces of metallic nanoparticles supported on oxide surfaces determine the activated dissociation of CO₂ in CO₂ hydrogenation. It also guides the catalytic pathway towards either CO₂ methanation or reverse water-gas shift (rWGS). Dr Yan prepared Ru/Al₂O₃ catalysts with different Ru structural configurations by controlling the Ru weight loadings, which revealed the structure-dependence of production rates for CO and CH₄ formation with different apparent activation energies (Figure 1.5). Different structure types of Ru sites on γ -Al₂O₃ were identified by the comprehensive analyses of H₂-O₂ titration, STEM, EXAFS and CO adsorption IRAS measurements. The monolayer and 3D nanocluster sites of Ru metals are co-existed in 1% Ru/Al₂O₃ catalyst while the latter predominates over 2% and 3% Ru/Al₂O₃ catalysts. Based on the characterisation results, two catalyst models were set up: the Ru₉/Al₂O₃ model consisted of an interface of monolayer Ru sites tightly contacted with γ -Al₂O₃ support, and the Ru₃₅/Al₂O₃ model represented a relatively larger Ru nanocluster supported on γ -Al₂O₃. Theoretical calculations over these two models demonstrated that monolayer Ru sites favoured the rWGS route with a relatively low energy barrier for both CO₂ activation and CO formation steps, while Ru nanoclusters preferred the methanation route energetically. In addition, a dynamic oxygen-exchange process between CO₂ and interfacial Ru-O-Al bond in monolayer Ru-catalysed rWGS reaction was validated by theoretical calculation

results and experimental isotope labelling studies. The dissociative adsorption of CO₂ at interfacial Ru sites leaves O* species to easily bridge with the surface Al sites from the support, building new Ru-O-Al bonds via the oxygen-exchange process. The observation in this work highlights the catalytic effects of the active metal-support interfaces in the effective activation of CO₂ for the exploration of the supported metallic catalysts.

Dr Yan also prepared Y₂O₃ supported Ni catalysts from different Y precursors. The catalysts synthesised via Y₄O(OH)₉(NO₃) and YO(NO₃) as precursors exhibit superior activity in CO₂ methanation reaction compared to the catalysts prepared by direct impregnation of Y₂O₃. YO(NO₃) acts as a unique matrix to afford anchoring sites to interact with Ni²⁺ ions, leading to a moderate interaction between Ni metal and Y₂O₃ support, which translates into excellent catalytic activity and stability towards CO poisoning. *In situ* DRIFTS spectra confirm the reaction mechanism of Ni/Y₂O₃ catalysed CO₂ methanation with carbonates and formates as the key intermediates. The apparent difference in the rate of transformation of formates into methane determines catalytic activity of these Ni/Y₂O₃ catalysts. This work provides an effective strategy to achieve CO₂ activation and resistance to CO poisoning through careful selection of precursor for the support, which allows the control of the strength of metal-support interaction.

Update on work package 1.3

New materials and MOFs

Dr TAN Ying Chuan (Research Assistant, NUS) reports that with the recent Paris climate agreement target to limit warming to 1.5 °C above pre-industrial times, reducing carbon emission is urgently required. This can be achieved through a combined effort of increasing energy efficiency, shifting away from fossil fuels and performing effective carbon capture and utilisation (CCU). Conversion of anthropogenic CO₂ to useful chemicals was envisioned in the late 20th century and an exponential increase in research interest has been observed ever since. In particular, significant progress of methanol synthesis from CO₂ hydrogenation has been achieved, though more improvement in the catalyst performance is still required for this process to be cost-effective. Conventional catalysts are derived conveniently from multi-metal copper-based layered double hydroxides (LDHs), however, the surface area of the resultant multi-metal oxides is usually low (~50 m² g⁻¹).

In this work, metal-organic frameworks (MOFs) are used as the precursor to derive catalysts for methanol synthesis. MOF-derived metal oxides are known to be porous and exhibit high surface area as the organic linkers serve as spacers between metal ions. However, MOFs are typically mono-metallic, and therefore not ideal to prepare catalysts for methanol synthesis. Ying Chuan was able to produce a range of multi-metal copper-based MOFs with varying metal ions (Figure 1.6), which can be conveniently converted to multi-metal oxides. Currently, systematic catalytic testing of these materials is ongoing.

Fig. 1.7: Schematic illustration for multi-functionalities of Ni/SiO₂@amNi-MOF-74 in tandem imination of nitrobenzene with benzaldehyde.

Bowen LI

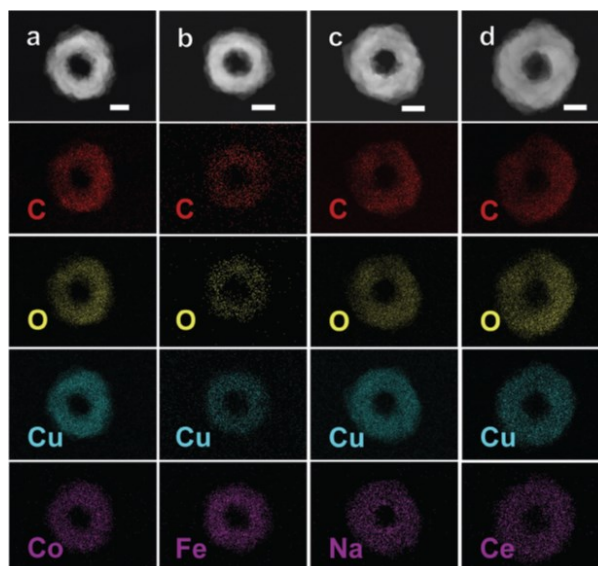
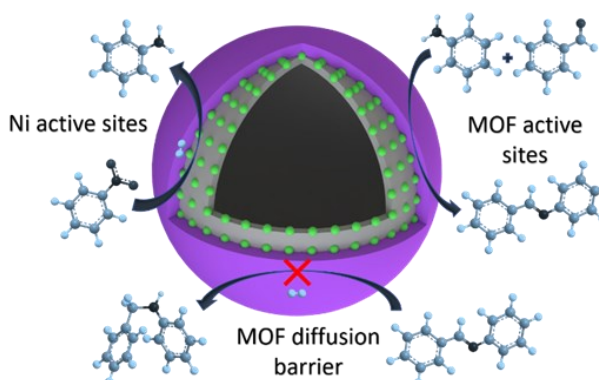

Fig. 1.6: HAADF-STEM images (scale bar: 300 nm) and the corresponding EDX elemental mapping images of different bimetal copper-based MOFs.

Dr TAN Ying Chuan

Bowen LI (PhD student, NUS) reports that synthesis of carboxylic-based amNi-MOF-74 coating shell onto Ni/SiO₂ hollow spheres has been developed using solid Ni NPs as precursor. This amNi-MOF-74 formation was examined to follow a stepwise oxidation-etching-coordination process in which oxidation of Ni to NiO has been proven to be the rate determining step. The as-prepared Ni/SiO₂@amNi-MOF-74 catalyst has been tested toward tandem imination of nitrobenzene with benzaldehyde. Apart from integrating Ni NPs with amNi-MOF-74, a combination of amNi-MOF-74's intrinsic active sites and well-defined pore channels played a vital role in achieving the desired product in this complex tandem reaction.

Organosilica spheres in the sub-micrometre range have been synthesised from 3-mercaptopropyltrimethoxysilane. It was found



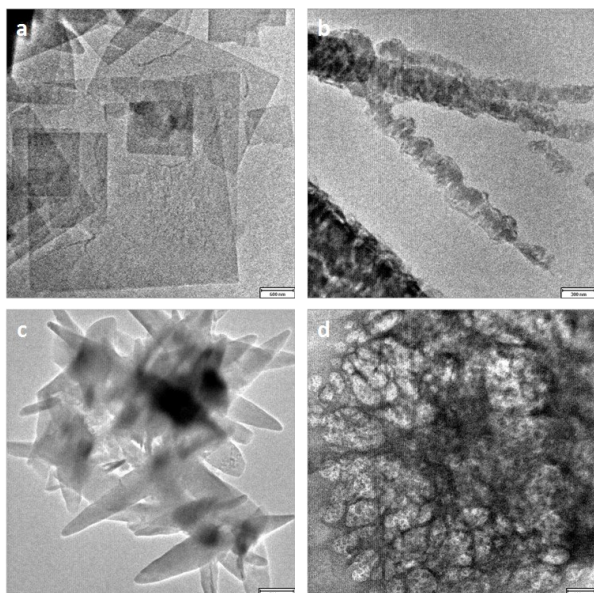

Fig. 1.8: TEM images of **a** CuBDC nanosheets, **b** CuBDC nanosheets after 2,5-dihydroxyterephthalic acid exchange, **c** CuBDC nanosheets after 2-aminoterephthalic acid exchange, **d** CuBDC nanosheets after 2-nitroterephthalic acid exchange.

Runze QIN

that such organosilica spheres could absorb various kinds of noble metal and transition metal ions into their structure. Organosilica@Pt and its derived Pt alloy catalysts have been tested toward CO₂ hydrogenation (gas-phase) and trans-cinnamaldehyde hydrogenation (liquid-phase) to demonstrate the catalytic potential of such materials. Synthesis of mesoporous organosilica template was also explored at the same time to further enhance the catalytic potential.

Runze QIN (PhD student, NUS) reports that metal-organic frameworks have raised enormous attention for their high specific surface area and tunable pore size. In Runze's recent work, 2D CuBDC nanosheets were firstly synthesised and then ligand exchange was conducted for these MOF nanosheets. It was found that when terephthalic acid ligand with different substitutes replaced the original organic ligand, it would change the morphology of nanosheet structure. Utilising AFM-Raman, Raman shifts could be observed based on different ligand exchange (Figure 1.8).

Jingjing WANG (PhD student, NUS): Recently, transition metal-based chalcogenides (especially sulfides) have attracted great attention as electro-

catalysts for oxygen evolution because of their low cost, easy fabrication process and good electronic conductivity. However, pure nickel sulfide nanostructures are still poor towards the catalytic activity of OER. To improve their catalytic ability, nickel sulfide-based heterogeneous nanostructures, such as MoS₂/Ni₃S₂, NiFe-LDH/Ni₃S₂ and PtNi/NiS have been reported (Figure 1.9). These heterogeneous nanostructures, showing the synergistically promoted kinetics on varied active sites and electron-reconfigured interfaces, are superior to their single-component counterparts for OER. To fulfil the synergy in heterostructures, rational engineering is necessary, in which the heterointerfaces of each component should be fully manifested, and the heterostructures should guarantee the fast mass/charge transportation and hydrophilic surface properties. In this regard, the heterogeneous nanostructures of metal chalcogenides and metal-organic frameworks (MOFs) which contain aquo- and hydroxo-rich nodes could be good candidates of OER electrocatalysts. However, these heterogeneous nanostructures have been rarely reported so far.

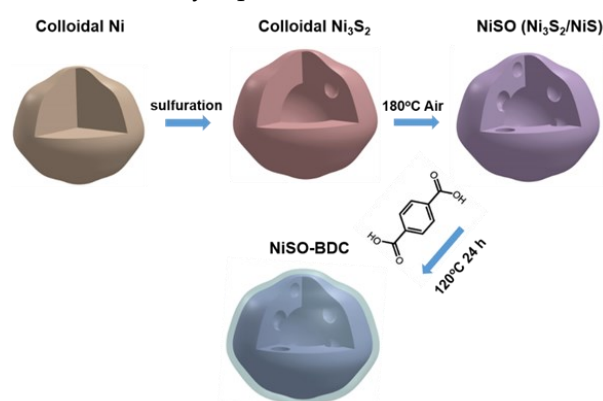
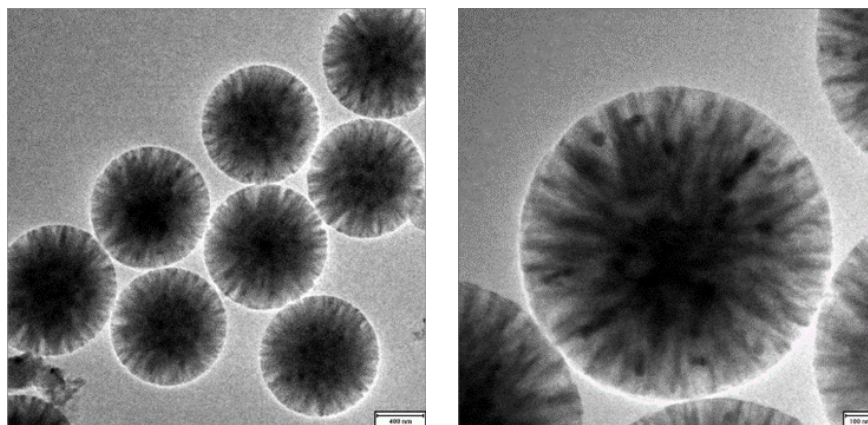

Fig. 1.9: Schematic illustration of the stepwise synthesis of NiSO-BDC.

Jingjing WANG

Fig. 1.10: TEM images of MASS-15 sphere loaded with Cu/ZnO using ion exchange method.

Jun Wen YEO



In the last half year, Jingjing has prepared a heterogeneous nanostructure of a Ni-based MOF modified NiS/Ni₃S₂ hollow nanoparticle. The OER catalytic activity of the heterogeneous catalyst is investigated, which shows greater enhancement than its single-component counterparts. Through mechanism study, the enhancement can be attributed to the synergistic effect of the advantageous heterogeneous structure, including the hydrophilia and coordinative unsaturation of Ni-BDC shell, the high conductivity and porosity of NiS/Ni₃S₂ core, as well as the strongly coupled interface between them.

Jun Wen YEO (PhD student, NUS) reports that nanostructures with potential for industrial adoption are identified and modified to form the industrially relevant Cu/ZnO catalysts for methanol synthesis from carbon dioxide hydrogenation. Specifically, mesoporous silica spheres (MSS), mesoporous aluminosilicate spheres (MASS) and layered double hydroxide nanostructures are chosen for their ease of synthesis and much lower cost, as well as being understood and commonly used as industrial catalyst supports.

MASS channels and Cu²⁺ or Zn²⁺ ions can provide

targeted loading of active species deep within the pores as opposed to near the sphere surface. Initial experiments reveal the successful loading of active components via this method, visible in the form of nanoparticles within the pores, as shown in Figure 1.10. However, the nanoparticles are too large (10-20 nm) and the catalytic activity is predictably unimpressive. Further work is being done to improve the activity so as to achieve a balance between Al incorporation and CO₂ hydrogenation activity.

Similar work is also being carried out on MgAl-LDH materials that form either flower-like or nanosheet morphology. In previous works these materials have been used as a cheap support for nanocrystals of metal-organic frameworks (nanoMOFs), as shown in Figure 1.11. Current experiments are aimed at utilising this method to synthesise Cu/ZnO loaded MgAl-LDH materials for CO₂ hydrogenation.

Dr Ping LI (Research Fellow, NUS) notes that developing cost-effective and earth-abundant noble-metal-free oxygen evolution reaction (OER) electrocatalysts with high activity and durability is highly desirable for future renewable energy sys-

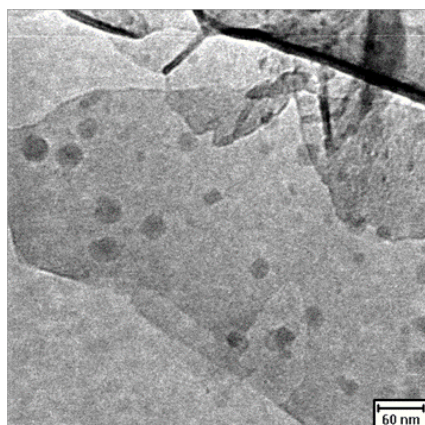

Fig. 1.11: NanoMOFs supported on easily synthesised MgAl-LDH materials.

Jun Wen YEO

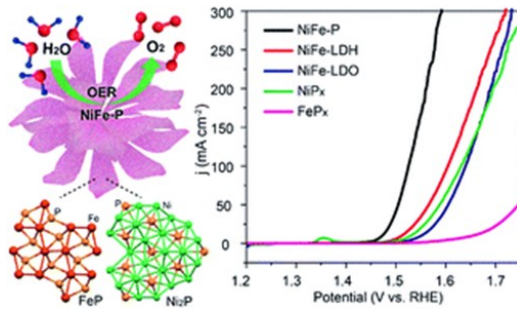

Fig. 1.12: Simplified illustration of the bimetallic Ni-Fe phosphide nanocomposite and its OER catalytic performance.

Dr Ping LI

tems. Herein, a facile and controllable approach is developed to engineer a series of structurally tiered bimetallic Ni-Fe phosphide nanocomposites with well-designed architectures and compositions through the topological conversion of the flowerlike precursor of Ni-Fe layered double hydroxides (LDHs). Remarkably, benefitting from their special physicochemical features and desirable synergistic effect, the resultant bimetallic phosphides can serve as a class of advanced high-performance electrocatalysts for water oxidation with an extremely low overpotential of 233 mV to deliver a current density of 10 mA cm⁻², a small

Tafel slope of 42.5 mV dec⁻¹, and strong durability (30 h of continuous water electrolysis), favourably representing the state-of-the-art level. This work elucidates the promising electrocatalytic performance of multinary transition-metal phosphides with controlled structures and compositions derived from LDHs for the OER.

Update on work package 1.4 Multi-scale modelling

ZHAO Ya (PhD student, NTU) is working on understanding the varying discharge rates of lognormal particle size distributions (PSDs) with the same mean particle diameter. Discrete element method (DEM) is used to simulate lognormal PSDs with the same arithmetic mean of the particle diameter of 5 mm but varying PSD widths ($\sigma/\mu = 10\%$ to 70%) in a 3D conical hopper. Some highlights are noted: (i) the Beverloo correlation and the modified correlations to account for various particle properties predict the discharge rates of lognormal PSDs poorly; (ii) the

velocity vectors are less uniformly downwards in the hopper for the wider PSDs, which results in the slowing down of the discharge rate; (iii) the radial particle velocity, and both the radial and vertical particle angular velocity. Both the radial and angular velocity increase with PSD width throughout the first half of the hopper discharge; and (iv) the collision force magnitudes are greater for the wider PSDs, and the cross-sectional fluctuations of the collision forces at the cone height increases with PSD width.

Fig. 1.13: Hoppers initialised with well-mixed particles of different particle size distributions (PSDs):

- (a) monodisperse
- (b) lognormal PSD with $\sigma/\mu = 10\%$
- (c) lognormal PSD with $\sigma/\mu = 30\%$
- (d) lognormal PSD with $\sigma/\mu = 50\%$
- (e) lognormal PSD with $\sigma/\mu = 70\%$

ZHAO Ya

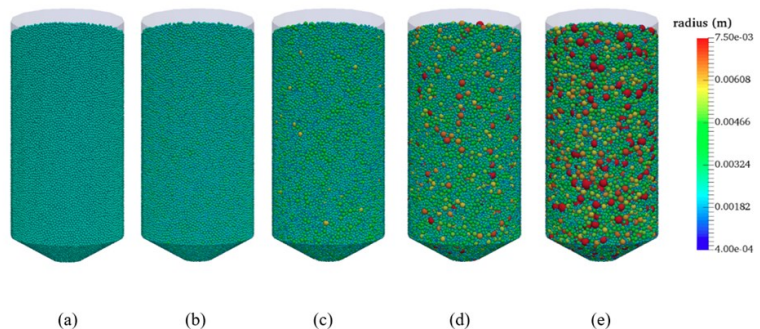

Update on work package 1.5

Fundamentals of adsorption and PSA

Prerna Goyal's (PhD student, NUS) research project aims to study drying of wet flue gas in the integrated Vacuum Swing Adsorption (VSA) process. The pilot plant rig has been extended to make provision to measure single component equilibrium isotherms by the constant volume method. Equilibrium isotherm data for adsorption of CO₂ and N₂ on silica gel up to 1 atm pressure at different temperatures have been measured in the constant volume apparatus. The data has been matched with the independent adsorption data measured using Micromeritics ASAP 2020 and good agreement is seen with the ASAP data (as shown in figure 1.14). The data are well captured by the Langmuir isotherm model. Transport mechanism for adsorption of N₂ and CO₂ on silica gel has also been established from Dynamic Column Breakthrough (DCB) experiments. The results show that the N₂ transport in silica gel is controlled by Knudsen diffusion in the pores. For CO₂, both Knudsen and surface flow are present. The surface diffusion component has been separated from the Knudsen contribution and it is shown that the surface diffusivity is practically constant in the adsorbed CO₂ concentration range expected in the VSA experiments. CO₂ breakthrough runs have been done at different temperatures to find out the activation energy for surface diffusion. Binary breakthrough experiments have been conducted for CO₂/N₂ mixtures in order to confirm the mixture equilibrium.

Measurement of equilibrium data for moisture

adsorption on silica gel and its transport mechanism in the pores are in progress. Breakthrough experiments for understanding competitive adsorption of CO₂, N₂ and moisture and confirm the mixture equilibrium are underway.

Future work will extend process simulations to three component simulation models. On the experimental front, the multi-purpose rig shall be used for conducting VSA experiments for drying of wet flue gas over a wide range of process conditions.

Dr Mark Purdue (Research Fellow, NUS) reports that in support of pilot plant adsorption process studies, independent adsorption equilibrium measurements were initially tested using thermogravimetric analysis but ultimately performed using a customised constant volume apparatus. This enabled pure dry gas dosing experiments at defined pressures on a known amount of regenerated adsorbent to provide for high quality equilibrium isotherm data for CO₂ and N₂ on silica gel. Comparative dynamic column breakthrough (DCB) experiments were subsequently supported and performed using Labview automatic control of gas flow operations. For this series of experiments, an *in situ* column regeneration method was proven effective to provide for silica gel regeneration at 150 °C with simultaneous vacuum and intermittent helium purge. High quality gas leak testing was established to ensure no disturbance of the system material balance during DCB experiments. In addition to DCB of N₂, CO₂ and

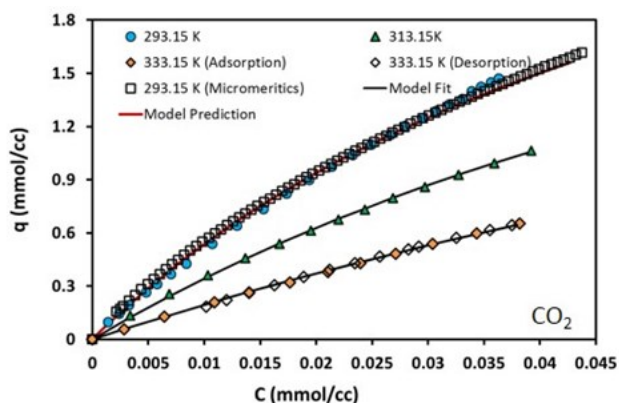

Fig. 1.14: Adsorption curves for CO₂.

Prerna Goyal



Fig. 1.15: Vacuum Swing Adsorption pilot plant rig.

dry flue gas mixtures in a 30 cm column, DCB was also performed using a custom-designed humidification system with a fast-response humidity sensor to study water vapour equilibrium and kinetics on silica gel. The adsorption column was interchanged for a 15 cm column, selected due to the significantly longer experimental times required for column saturation to occur. With wet flue gas adsorption equilibria and kinetics on silica gel established experimentally, a three-step Vacuum Swing Adsorption (VSA) process for moisture capture using feed pressurisation, high pressure adsorption and reverse evacuation shall next be investigated. Power logging of electrical energy consumption by a vacuum pump and gas composition analysis by mass spectrometry shall assist to develop the understanding of employing a silica gel column to guard downstream adsorption columns used for carbon capture. This shall be followed by pilot plant studies of dual column VSA using silica gel and Zeolite 13X adsorption columns in series.

Separately, numerical process simulations of DCB were performed using NAG Fortran for the adsorption of dry flue gas on Zeolite 13X using a novel equilibrium isotherm to account for supplementary N_2 adsorption on CO_2 . Further, VSA process simulations were performed using an established four-step VSA process with light product pressurisation. A novel adsorption equilibrium isotherm model for wet flue gas adsorption on Zeolite 13X has been included in the process simulations for dual column VSA for carbon capture from wet flue gas. The process model has been kept flexible to allow for different scheduling operations for validation against the CARES pilot plant studies and for scaling up to determine the levelised cost of electricity generation from a 630 MW power plant with carbon capture units for continuous processing of wet flue gas. The process model enables results to be numerically compared to a dual column VSA process with an alternative established six-step VSA cycle for carbon capture.

Scientific output

The following are some examples of CREATE-acknowledgement papers generated by IRP1 during the reporting period. A full list of publications may be found on page 87.

Lewis basicity generated by localised charge imbalance in noble metal nanoparticle-embedded defective metal-organic frameworks

Ying Chuan Tan and Hua Chun Zeng

DOI: 10.1038/s41467-018-06828-4

Abstract: Interactions between metal nanoparticles (NPs) and metal-organic frameworks (MOFs) in their composite forms have proven to exhibit beneficial properties, such as enhanced catalytic performance through synergistic effects. Herein, we show that Lewis basic sites can be created within an anionic defective MOF by engineering the electronic state of the pendant carboxylate groups situated at the defect sites. This is achieved from the concerted interactions between the pendant carboxylate groups, embedded Pd NPs and charge-balancing cations ($M^{n+} = \text{Ce}^{3+}$,

Co^{2+} , Ni^{2+} , Cu^{2+} , Mg^{2+} , Li^+ , Na^+ or K^+). This work is the first example of generating a new collective property, i.e. Lewis basicity, in metal-carboxylate MOFs. Importantly, the choice of M^{n+} , used during cation exchange, acts as a convenient parameter to tune the Lewis basicity of the MOF-based nanocomposites. It also provides a facile way to incorporate active metal sites and basic sites within carboxylate-based MOFs to engineer multifunctional nanocatalysts.

Schematic illustration of the stepwise preparation of Pd/M-HKUST-1-R. HKUST-1-R undergoes an in situ reduction of Pd^{2+} to form Pd/HKUST-1-R (step i) and subsequent cation exchange with M^{n+} (where $M^{n+} = \text{Ce}^{3+}$, Co^{2+} , Ni^{2+} , Cu^{2+} , Mg^{2+} , Li^+ , Na^+ or K^+) forms Pd/M-HKUST-1-R (step ii)

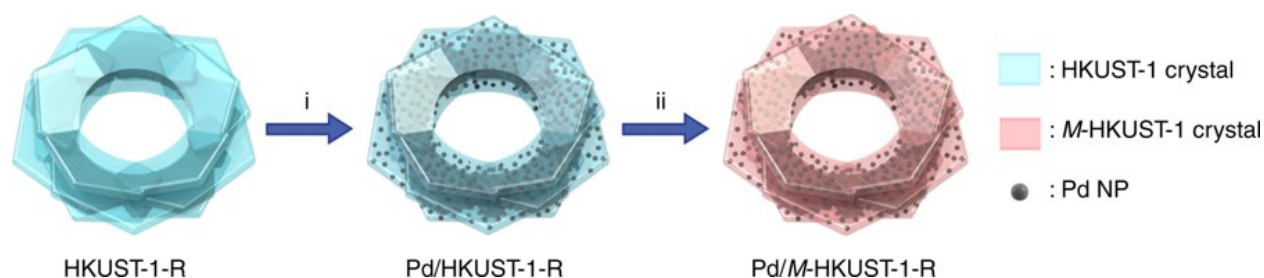

Improved stability of Y_2O_3 supported Ni catalysts for CO_2 methanation by precursor-determined metal-support interaction

Yong Yan, Yihu Dai, Yanhui Yang and Alexei Lapkin

DOI: 10.1016/j.apcatb.2018.06.021

Abstract: Y_2O_3 supported Ni catalysts were prepared from different Y precursors. The catalysts synthesised via $\text{Y}_4\text{O}(\text{OH})_9(\text{NO}_3)$ and $\text{YO}(\text{NO}_3)$ as precursors exhibit superior activity in CO_2 methanation reaction compared to the catalysts prepared by direct impregnation of Y_2O_3 . $\text{YO}(\text{NO}_3)$ acts as a unique matrix to afford anchoring sites to interact with Ni^{2+} ions, leading to a moderate interaction between Ni metal and Y_2O_3 support, which translates into excellent catalytic ac-

tivity and stability towards CO poisoning. *In situ* DRIFTS spectra confirm the reaction mechanism of $\text{Ni}/\text{Y}_2\text{O}_3$ catalysed CO_2 methanation with carbonates and formates as the key intermediates. The apparent difference in the rate of transformation of formates into methane determines catalytic activity of these $\text{Ni}/\text{Y}_2\text{O}_3$ catalysts. This work provides an effective strategy to achieve CO_2 activation and resistance to CO poisoning through careful selection of precursor for the support, which allows to control the strength of metal-support interaction.

Accompanying graphical abstract >

Architectural Designs and Synthetic Strategies of Advanced Nanocatalysts

Guowu Zhan, Ping Li and Hua Chun Zeng

DOI: 10.1002/adma.201802094

Abstract: Advanced nanocatalysts with high compositional and structural tailorability have emerged as a new class of heterogeneous catalysts exhibiting many new technical merits over their conventional counterparts. Generally, preparation of such catalysts involves the integration of cata-

lyst components with compositional, size, and shape controls into a larger material system in order to bring along collective and synergetic effects of individual components. Herein, a brief review of architectural designs and synthetic strategies for making these nanocatalysts is presented. Due to length constraints, only four major types of them are highlighted together with some general rules of design and synthesis. Finally, a critical outline of future perspective in this field is proposed.

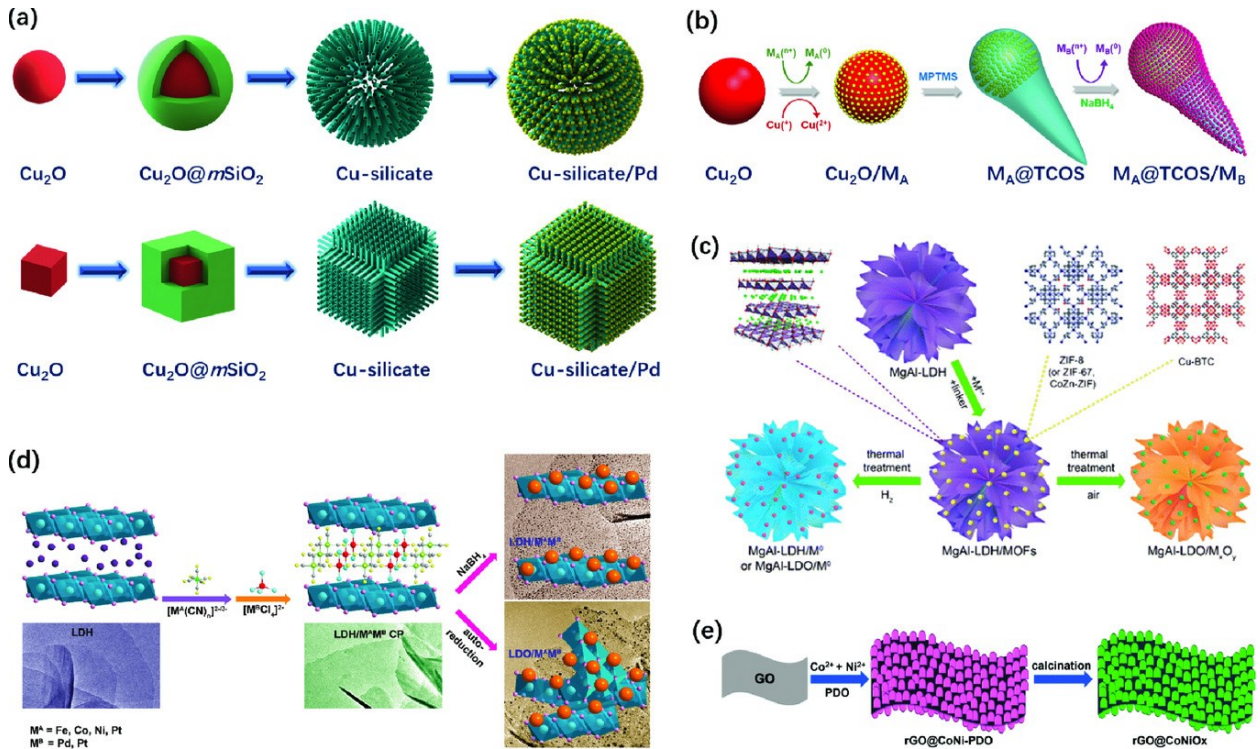

Schematic illustrations of preparation of supported nanocatalysts.

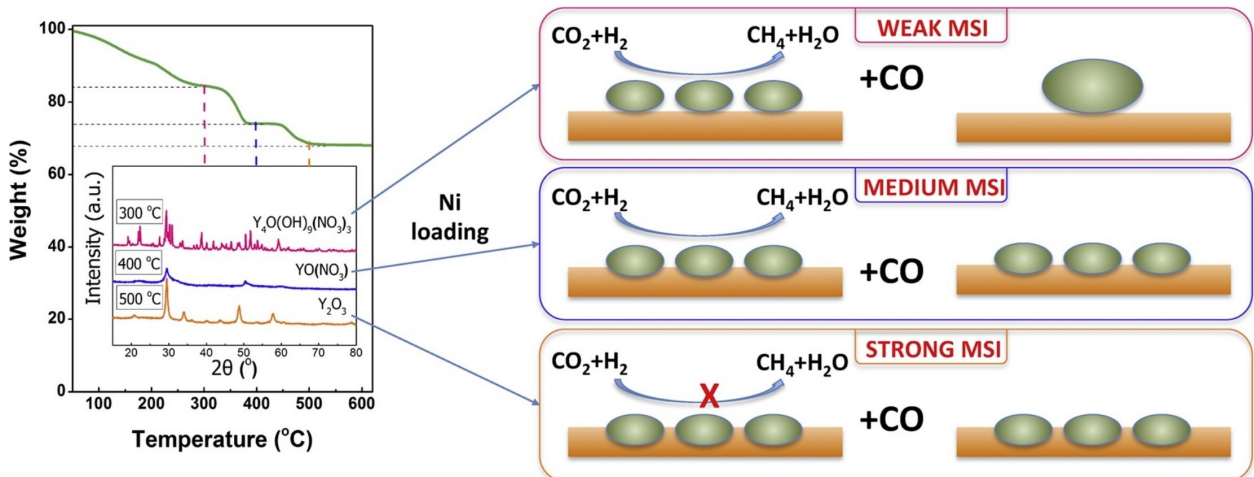

Other activities and achievements

Many members from IRP1 presented their research at the SWITCH tech trade fair. An augmented reality display was used to enable the conference attendees to interact and explore the nanostructures synthesised by the group.

Nicholas Jose and his supervisor Prof. Alexei Lapkin have written a book chapter titled "Influence of hydrodynamics on wet synthesis of nanomaterials". The book, *Advanced Nanomaterials for Catalysis and Energy*, will be published in 2019:

N. Jose, A. Lapkin, Influence of hydrodynamics on wet syntheses of nanomaterials, in "Advanced Nanomaterials for Catalysis and Energy", Ed. V.A. Sadykov, Elsevier, Amsterdam, 2019. pp. 29-60.

Prof. Lapkin has edited a book called *Green Chemical Engineering*, which has been published and includes two chapters by him:

Lapkin, Chemical engineering science and green chemistry - the challenge of sustainability, in "Green Chemical Engineering", v.12 Handbook of Green Chemistry,

Series ed. P. Anastas, Volume ed. A. Lapkin, Wiley-VCH, 2018. pp. 1-18.

C.S. Horbaczewskyj, C.E. Willans, A.A. Lapkin, R.A. Bourne, An introduction to closed-loop process optimization and online analysis", in "Green Chemical Engineering", v.12 Handbook of Green Chemistry, Series ed. P. Anastas, Volume ed. A. Lapkin, Wiley-VCH, 2018. pp. 329-374.

Dr YAN Yong presented his work 'Improved stability of Y_2O_3 supported Ni catalysts for CO_2 methanation by precursor-determined metal-support interaction' at the 10th International Conference on Environmental Catalysis in Tianjin, China, in September.

Dr YAN Yong at the 10th International Conference on Environmental Catalysis



Cambridge CARES' display at Singapore Week of Innovation & TeCHnology (SWITCH).

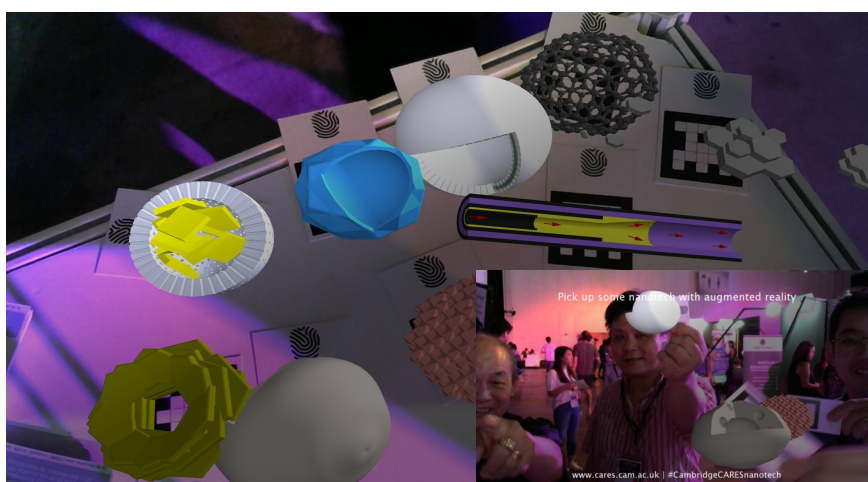

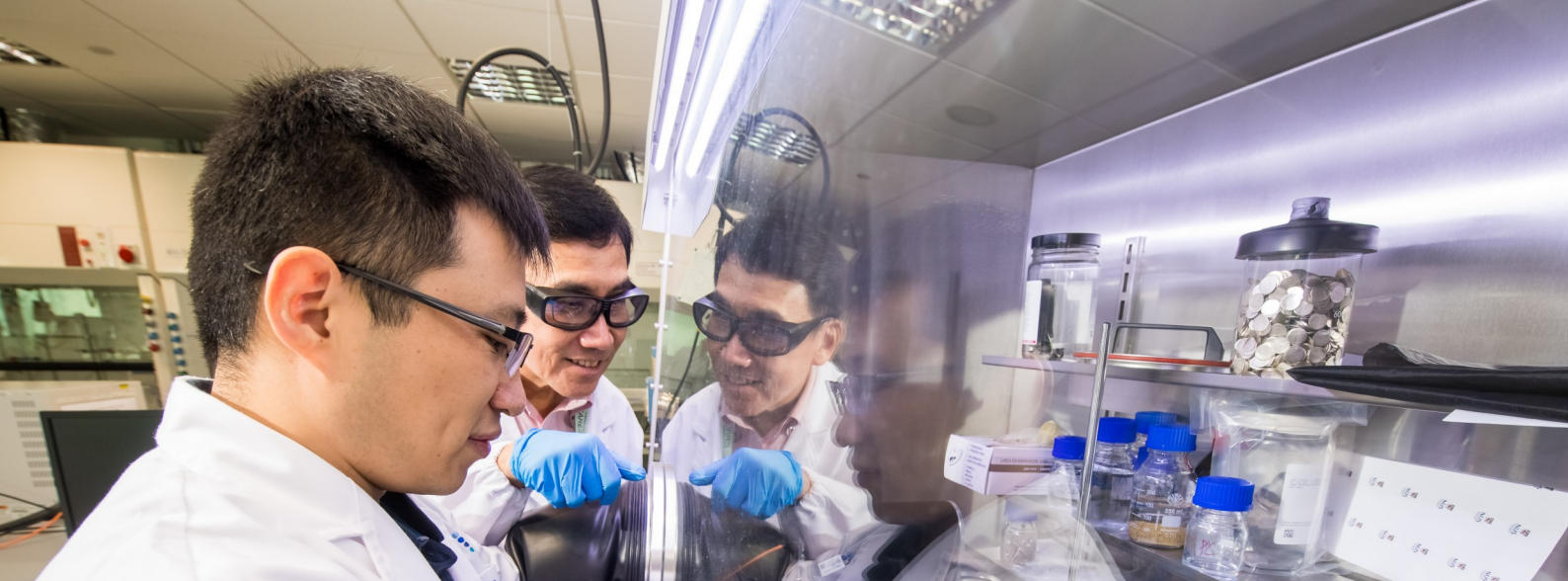

IRP2: EMSET

ELECTROCHEMICAL MULTI-SCALE SCIENCE, ENGINEERING AND TECHNOLOGY

The EMSET programme targets the exploitation of renewable sourced electrons for the production of value added chemicals. The aim of these new technologies and synthetic routes focuses on the development and exploitation of novel technologies which lead to a net reduction in CO₂ emissions for chemical production. The three core thrusts to EMSET are 1) the development of high resolution electrochemical methods using big data approaches which can be exploited to gain quantitative understanding of the physical and chemical processes that limit efficient electrical conversion, 2) the investigation and discovery of advanced catalysts, electrode architectures and the wiring of these complex structures to ensure optimal conversion rates and 3) the development of integrated advanced reactor systems.

EMSET is led by PIs:

Dr Adrian Fisher (CAM)

Prof. Xin WANG (NTU)

Prof. Jim Yang LEE (NUS)



OVERVIEW

In the latest reporting period, significant advances in our core research areas have been achieved. In collaboration with Prof. Erik Birgersson (Co-PI, NUS), Dr Ashoke Raman Kuppa (Research Fellow, NUS) has continued his studies in the area of advanced numerical analysis. The design of the electrochemical reactors have been a core focus, with Vishvak Kannan (PhD student, NUS) exploring statistical analyses to optimise the working conditions of a galvanic electrochemical reactor. These will be exploited for applications in our reactor engineering investigations and in due course facilitate in-design optimisation.

PhD student WANG Yian's (CAM) work has focused on further numerical analysis of energy related electrochemical reactions and development of the numerical models in particular focused on energy storage systems. This builds on Vishvak's work noted in the previous biannual report, which explored advanced protocols for electrochemical control and analysis. In particular the exploration of optimal voltage waveform protocols has been exploited to quantify the highly non-linear i/V parameters linked to electrolytic reaction.

In collaboration with Prof. Xu ZHICHUAN (Co-PI, NTU) Dr Chencheng DAI (Research Fellow, NTU) has continued the development of efficient strategies for the electrochemical production of lactic acid and other higher value mark up products. In this reporting period, new reactors and flow rigs have been designed and constructed for variable pressure and temperature studies to be undertaken next.

In new developments working with Prof. Jim Yang LEE (PI) at NUS, we have been applying novel electrochemical strategies in the area of smart energy-saving materials. In particular the development of metal-doped TiO_2 colloidal nanocrystals with broadly tunable plasmon resonance absorption characteristic has been successfully delivered with NUS IRP2 team Shengliang ZHANG, Dr Sheng CAO and Dr Tianran ZHANG. This links strongly to our collaborations with the Cambridge civil engineering professor Abir Al-Tabbaa.

The development of the IRP2 international outreach programme has expanded significantly within the current reporting period. October 2018 saw the launch of an advanced sensors and techniques masterclass in the UK in collaboration with ANB Sensors and STEMNOVATE. This new masterclass programme highlights IRP2 developments in the area of electrochemical sensing and applications. Delegates from local Cambridge companies attended the two-day programme. Our collaboration with Metrohm has also continued to develop with masterclass activities in Australia (December 2018) and Singapore (June 2019) already confirmed for the next reporting period.

Dr Adrian Fisher, PI
University of Cambridge

Update on work package 2.1

Numerical multi-scale electrochemical modelling and analysis

In this report Vishvak Kannan (PhD student, NUS) gives a summary of the progress in mechanistic modelling of different configurations and modes of operation of a galvanic electrochemical reactor (ECR) is presented. A one-phase, steady state was solved and reported earlier. Following this a two-phase steady state model was set up which considers the spatial distribution of liquid water and saturation within the porous regions. This model was experimentally validated and was used as a base case, where further modifications to include the effect of different configurations and operating conditions, were carried out.

Following the steady-state models, Vishvak has set up transient models to capture the dynamic effects of different modes of operation and working conditions. One such mode of operation is operating the galvanic ECR under a controlled current short circuit (CSC). CSC has been reported to improve the performance of the galvanic ECR, but the exact reason for the improvement is still unclear. Although there are a few hypotheses that have been reported in literature, the evidence for these is lacking. In order to obtain deep insights into this phenomenon, mathematical models incorporating CSC and the hypotheses available in literature are being solved. These models are solved in both dead-ended and open-ended anode configurations. In the case of a dead-ended

anode system, the flow channel is periodically purged, and this is also considered in the mathematical model.

Vishvak will also carry out statistical analyses to optimise the working conditions of the ECR in tandem. The statistical analyses include a Monte Carlo based uncertainty analysis and a sigma-normalised derivative based sensitivity analysis along with linear regressions. Different parameters to which the system is sensitive are varied simultaneously at random around a prescribed mean with a standard deviation following a normal distribution. Such a random, simultaneous variation of multiple parameters allows a numerical evaluation of the system which is closer to reality and helps in identifying failure modes and optimal working conditions.

WANG Yian's (PhD student, CAM) main research area lies in the investigation of conventional electrochemical reactions and development of the numerical models to quantify energy storage systems. Since starting the second year of his PhD at Cambridge CARES, he has focused on studying the realistic electrocatalytic process for redox systems which cannot be achieved by conventional techniques. Jointly with Dr Kamal Elouarzaki (Research Fellow, NTU), one paper on quantitative mechanistic insights into a hydrogenase-like reaction has already been completed and submit-

Fig. 2.1: Temperature distribution in a galvanic electrochemical reactor operating at 0.2 V.

Vishvak KANNAN

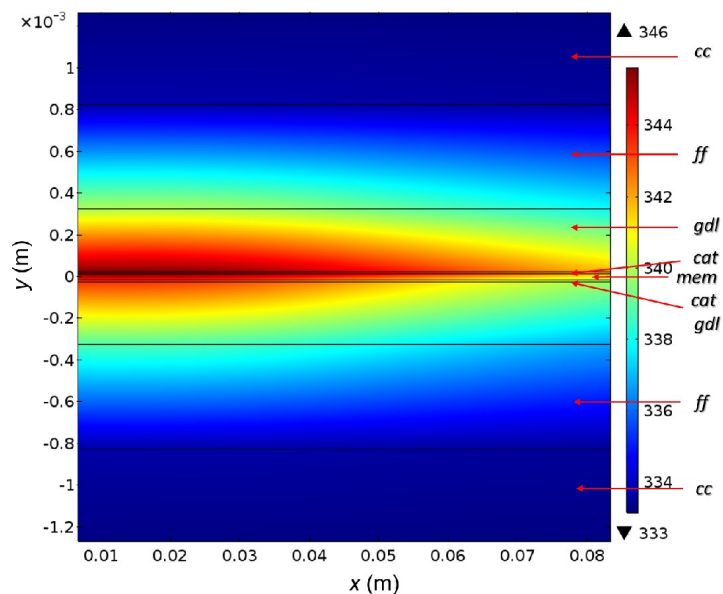

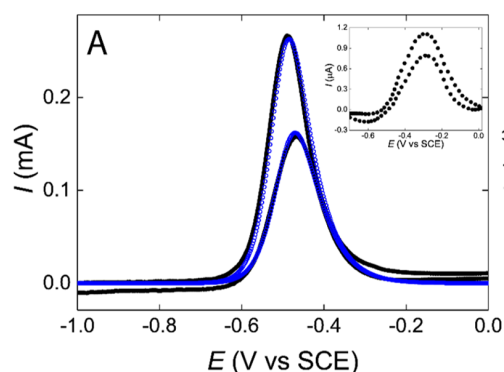

Fig. 2.2: Validation of the model predictions for the electrocatalysis of (DPDE)Rh^{III} and the kinetic parameters as a function of the applied potential. Inset: Voltammogram of hydrogenase. Experimental validation of the model predictions showing the electrochemical reactivation of (DPDE)Rh^{III} catalyst in the presence of 50 mM glucose in pH 14 and at $v = 10 \text{ mV s}^{-1}$ (A). Voltammogram of hydrogenase with an [NiFe] active site at 45 °C in pH 7.4 under H₂ and at $v = 5 \text{ mV s}^{-1}$ is presented in the inset (A).

WANG Yian

ted to a high-impact journal. Figure 2.2 shows the validations between experimental data and numerical simulations giving an excellent agreement in such a complex system. Yian and Kamal are now preparing a second chapter on using an alternative chronoamperometric voltammetry to explore the same electrocatalytic system in order to capture more unusual current features from the experiments. As a fourth year PhD student, Yian has completed his final dissertation and submitted to the University of Cambridge.

Yian's main work in the current stage describes the investigation of a unique current behaviour generated from a chosen electrochemical system, in which a totally inverted backward peak occurs on the reversal scan by cyclic voltammetry (Figure 2.2 inset). This specific example has recently been reported in the open literature based on non-enzymatic catalyst by preparing rhodium-porphyrin catalyst on a multi-walled carbon nanotube matrix. Such a phenomenon has been observed in literature for only surface-confined hydrogenase, which exhibits electrocatalytic inactivation and activation processes (IAPs). A very detailed mechanistic analysis is carried out to understand the thermodynamics and kinetics of IAPs and the stepwise investigations offer a mechanism for glucose oxidation which proceeds

an EC'CE scheme with catalytic steps like the ones presented for hydrogenase.

We are now employing a deeper investigation of the same electrocatalytic inactivation and activation processes (IAPs) by chronoamperometric voltammetry. The important kinetic parameters are obtained through an alternative technique. The approach surprisingly leads to an unexpected difference between the anodic and cathodic peak current at a far more negative potential. Cyclic voltammetry is used again with increased sweeping range; as a result, an additional reduction peak is observed at $-1.15 \pm 0.05 \text{ V}$ under low scan rate ($< 50 \text{ mV/s}$). This observation implies extra electrochemical (coupled with chemical) steps in the system, which is resulted from the formation of dimeric rhodium intermediates. The implementation of computational-based model is utilised to quantitatively analyse the dimer formation scheme, and the more comprehensive mechanism of the surface-confined rhodium-porphyrinic catalyst is summarised in Figure 2.3.

Fig. 2.3: Overall catalytic cycle including rhodium dimer formation. The red arrows represent the very fast electron transfer step. The rest of the arrows in different colours represent different chemical steps.

WANG Yian

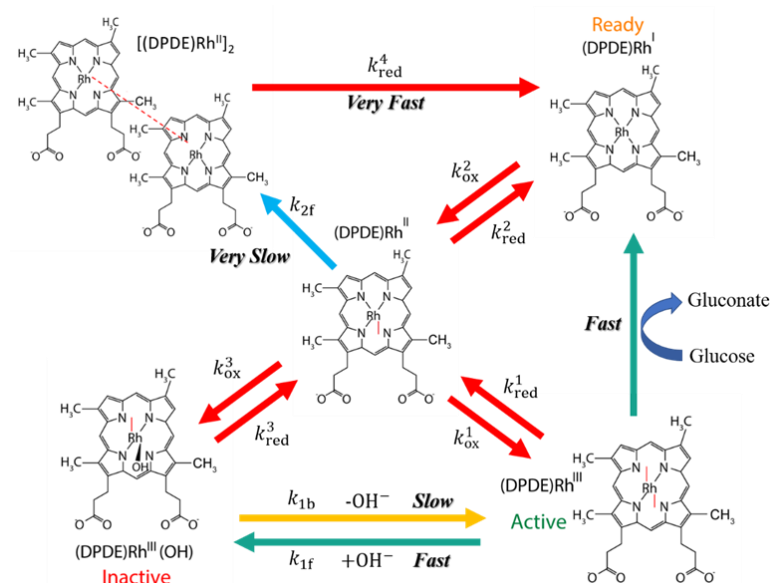

Update on work package 2.2

Electrode development and testing

Naziah binte Mohamad Latiff (PhD student, NTU) reports that with climate change, global warming, depleting amount of fossil fuels and rising energy demands, it becomes critical for us to search for practical energy solutions. In this endeavour, layered materials such as graphenes, transition metal dichalcogenides (TMDs) and black phosphorus have demonstrated promising properties as new materials for applications in enhanced energy storage and generation systems such as batteries, supercapacitors and fuel cells. In the heart of these devices, electrochemistry plays a central role in their operation. Therefore, we are interested to investigate the electrochemical properties of layered materials to develop on their performance for such applications. To further advance our current understanding in these areas, we studied the effects of dopants in microwave exfoliated graphene on their capacitive performance, as well as the effect of valence and oxide impurities in two common TMDs (i.e. MoS_2 and WS_2) on their electrocatalytic hydrogen production for use in fuel cells. Besides technological advancement, we also recognise that there is growing concern over the potential health and environmental hazards posed by these layered materials. As such, we also investigated the cytotoxicity of several new emerging layered materials to conduct preliminary toxicological studies.

We have chosen vanadium dichalcogenides and black phosphorus to address this research gap. These electrochemical and cytotoxicity studies would be useful for the progression of our endeavour towards sustainable clean energy.

Nur Farhanah Binte Rosli's (PhD student, NTU) recent work investigated the cytotoxicity and electrochemical properties of MAX and MAB phases. MAX and MAB phases are layered ternary carbides, nitrides and borides consisting of a transition metal (M), an A-group element (A) and carbon/nitrogen/boron (X/B). Investigating the cytotoxicity of MAX and MAB phases is necessary as their toxicity has yet to be known and understanding their potential health risk is important prior to any future applications. Nur Farhanah's investigations showed that MAX and MAB phases possess negligible toxicity to lung cancer cells (A549), kidney cells (HEK 293), breast cancer cells (MCF-7) and liver cancer cells (HEP G2), which suggest that they are safe materials for future applications and are possibly biocompatible for biological applications. In addition, she is currently exploring their performance as catalyst for reactions in clean energy generation such as hydrogen evolution reaction (HER), oxygen reduction reaction (ORR) and oxygen evolution reaction (OER).

Fig. 2.4: Overview of PhD work 'Layered materials for energy applications: Electrochemistry and toxicity studies'. Naziah binte Mohamad Latiff

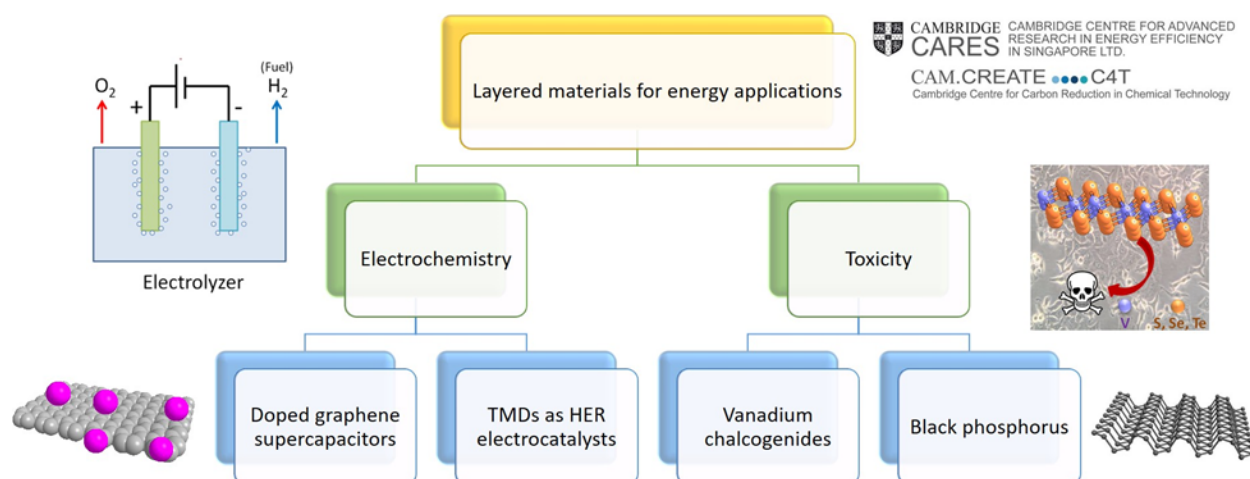
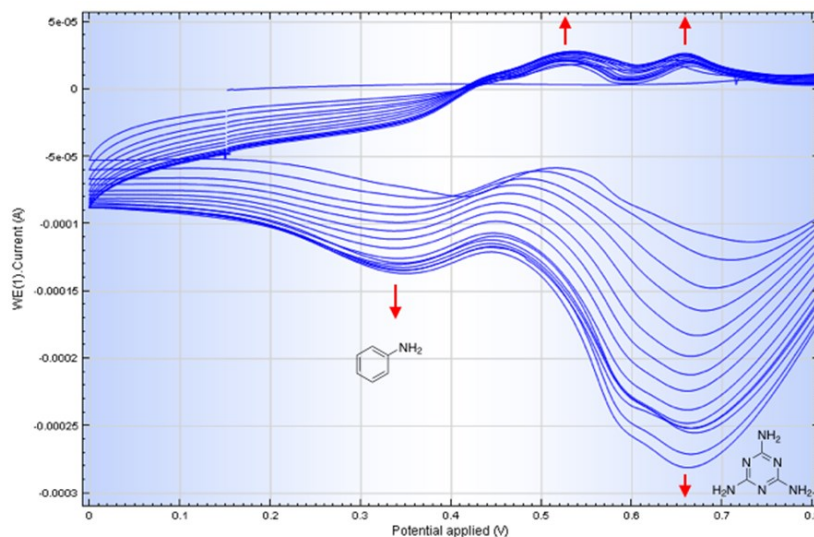

Fig. 2.5: Cyclic voltammogram of the electro(-co)-polymerisation of 1 mM aniline and 3 mM melamine in 1.0 M HCl solution on a SPCE containing AuNPs and MWCNT-COOH at a scan rate of 20 mV s⁻¹.

Guo Xiong THAM



Guo Xiong THAM (PhD student, NTU) is currently working on the electro-co-polymerisation of multiple monomers to produce a conductive polymer film that can possibly be used in energy storage devices. The investigation of the type of electrolyte, switching potential and the monomeric ratio can result in differing electrochemical behaviour of the electrosynthesis of poly (aniline-co-melamine) on the surface of the working electrode. To achieve the maximum oxidation peak current of PMEL, different concentration monomeric ratios of melamine and aniline were used with 3:1 as the optimum ratio required to do so. The oxidative peak potentials of PANI and PMEL were shifted to more and less positive potentials respectively as the number of potential cycles increased. The use of gold nanoparticles (AuNPs) was also employed on a screen-printed carbon electrode (SPCE). Coupled with the use of carboxylic acid functionalised carbon nanotubes on the SPCE, electropolymerisation was also achieved but further work needs to be done on the improvement of the current intensity.

Dr DAI Chencheng, Research Fellow, NTU:

An electron deficiency strategy for enhancing hydrogen evolution on CoP nanoelectrocatalysts: Optimising the hydrogen adsorption on electrodes is one of the most effective strategies to promote the hydrogen evolution reaction (HER). In recent years, cobalt phosphides (CoP) have been identified as a promising catalyst for HER in acid. However, the hydrogen adsorption on CoP is strong and a considerable overpotential has to be applied to enable HER. Here, we

report a strategy to weaken the hydrogen adsorption on CoP through an electron deficiency in CoP induced by Au@CoP core/shell structure. A weakened hydrogen adsorption is confirmed by the density functional theory (DFT) calculation. Au@CoP gave an overpotential (η) of 160 mV at the current density of 1 mA cm⁻²CoP, which is about 50 mV less than pure CoP. It also exhibited a turnover frequency (TOF) value of 0.68 s⁻¹ per active site at η = 150 mV, which is more than four times higher than CoP. The strategy reported here holds potential to be extended to other electrodes for optimising their hydrogen adsorption for HER.

Degree of Geometric Tilting Determines the Activity of FeO₆ Octahedra for Water Oxidation: Fe oxides and (oxy)hydroxides are promising cost-effective catalysts for scalable water electrolysis. For an improvement in the understanding of the structural factors required by the most active Fe sites, the role of geometric tilting in determining the activity of the FeO₆ octahedron for water oxidation was investigated. The catalytic performance of the FeO₆ octahedron in a series of crystalline structures, i.e., perovskites AFeO₃, spinel ZnFe₂O₄ and β -FeOOH, was found to be negatively correlated with their octahedral tilting degree. This correlation was rationalised through the Fe-O covalency, which is reflected by the O 2p band centre as well as the charge-transfer energy obtained from ab initio calculations. Thus, it was disclosed that FeO₆ octahedral tilting alters the activity for water oxidation through changing the covalency degree of Fe-O bonds.

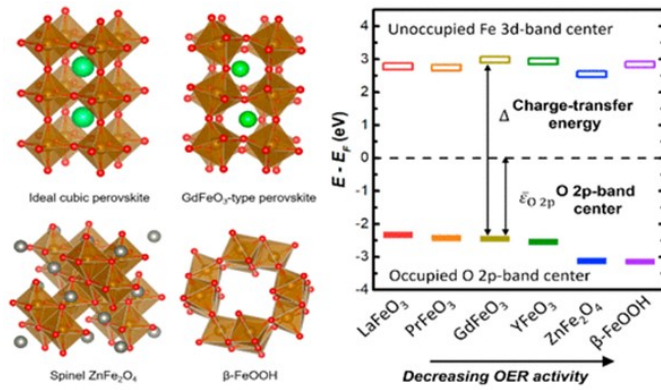

Fig. 2.6: Degree of geometric tilting determines the activity of FeO_6 octahedra for water oxidation.

Guo Xiong THAM

Enlarged Co-O Covalency in Octahedral Sites Leading to Highly Efficient Spinel Oxides for Oxygen Evolution Reaction: Cobalt-containing spinel oxides are promising electrocatalysts for the oxygen evolution reaction (OER) owing to their remarkable activity and durability. However, the activity still needs further improvement and related fundamentals remain untouched. The fact that spinel oxides tend to form cation deficiencies can differentiate their electrocatalysis from other oxide materials, for example, the most studied oxygen-deficient perovskites. Here, a systematic study of spinel $\text{ZnFe}_x\text{Co}_{2-x}\text{O}_4$ oxides ($x = 0 - 2.0$) toward the OER is presented and a highly active catalyst superior to benchmark IrO_2 is developed. The distinctive OER activity is found to be dominated by the metal-oxygen covalency and an enlarged Co-O covalency by 10–30 at% Fe substitution is responsible for the activity enhancement. While the pH-dependent OER activity of $\text{ZnFe}_{0.4}\text{Co}_{1.6}\text{O}_4$ (the optimal one) indicates decoupled proton-electron transfers during the OER, the involvement of lattice oxygen is not considered as a favourable route because of the downshifted O p-band centre relative to Fermi level governed by the spinel's cation deficient nature.

Metal-Oxygen Hybridisation Determined Activity in Spinel-Based Oxygen Evolution Catalysts: A Case Study of $\text{ZnFe}_{2-x}\text{Cr}_x\text{O}_4$: A good understanding of the correlation between electronic properties and catalytic performance is vital to the rational design of active oxygen evolution reaction (OER) catalysts. Here, a volcano-shaped correlation between the OER activity and the Cr substitution amount was found for spinel oxides $\text{ZnFe}_{2-x}\text{Cr}_x\text{O}_4$ ($x = 0-2$), in which Zn^{2+} resides in tetrahedral (Td) sites while Fe^{3+} and Cr^{3+} occupy octahedral (Oh) sites. Such a relationship is probably because Cr substitution tunes the eg occupancy of Oh-site transition metals (TMOh) via the Oh-Oh super exchange effect. Density functional calculations further revealed the hybridisation degree between the TMOh 3d and the O 2p states, and a volcano-shaped trend was also found in the variation of TMOh 3d-O 2p hybridisation with the amount of Cr substitution. The good correlation between the OER activity and the hybridisation highlights the important role of metal-oxygen hybridisation in determining the OER activity of these spinel oxides.

Fig. 2.7: Metal-oxygen hybridisation determined activity in spinel-based oxygen evolution catalysts: a case study of $\text{ZnFe}_{2-x}\text{Cr}_x\text{O}_4$.

Guo Xiong THAM

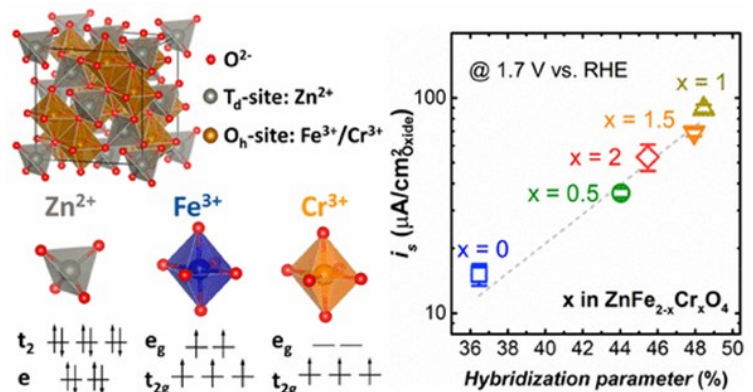

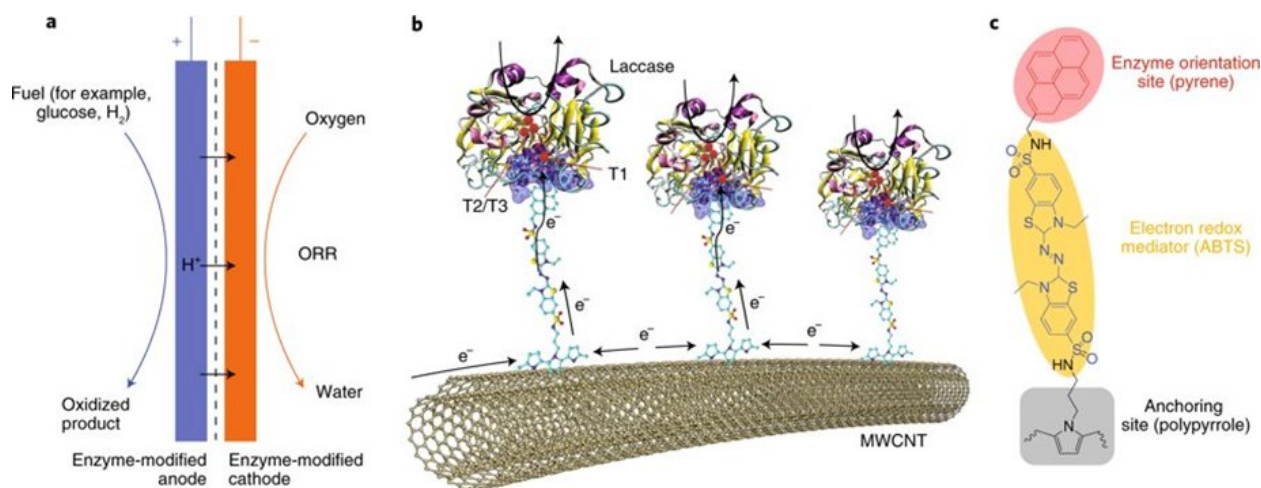

Fig. 2.8: **a** Redox enzymes facilitate oxidation of biofuels at the anode and reduction of oxygen to water at the cathode. **b** Laccase as an enzyme catalyst. **c** Electron transfer system.

Dr Kamal Elouarzaki

Dr Kamal Elouarzaki (Research Fellow, NTU) reports that enzymatic biofuel cells (BFCs) employ enzymes as electrocatalysts to convert chemical energy of biofuels such as sugars, alcohols and hydrogen into electrical energy. As illustrated in Figure 2.8a, redox enzymes facilitate oxidation of biofuels at the anode and reduction of oxygen to water at the cathode, generating electric power in doing so. Compared to conventional fuel cells, BFCs offer several advantages including the cost-benefit of using enzymes in place of precious metal catalysts, versatility of fuel choices, feasibility for miniaturisation and ability to operate at mild conditions. However, the development of BFCs suffers from their limited power output, short lifetime and low efficiency. All these drawbacks can be attributed to the sluggish electron transfer process between enzymes and electrode surfaces. Currently, the design strategies to facilitate the electron transfer are based on either a direct electron transfer (DET) or a mediated electron transfer (MET) mechanism. In the DET mechanism, an enzyme is electrically connected (or immobilised) to an electrode surface and electrons directly tunnel between the enzyme and the electrode. In the MET mechanism, on the other hand, a MET mediator, such as a metal complex-based polymer, is used; the MET mediator undergoes redox reactions at an electrode surface but it is also able to exchange electrons with the enzyme so that electrons are shuttled via the MET mediator. Writing in *Nature Energy*, Dr Elouarzaki proposed a de-

sign principle for efficient electron transfer by coupling both DET and MET mechanisms.

In their approach, the researchers chose laccase as the enzyme catalyst (Figure 2.8b). With this, they developed a multi-functional electron transfer system (Figure 2.8b, c) that was immobilised on a carbon nanotube (MWCNT) surface. Their electron transfer system includes three parts, a 2,2'-Azino-bis(3-ethylbenzthiazoline-6-sulfonic acid) (ABTS) compound in the middle with a pyrene group at one end and a polypyrrole group at the other end. It is denoted as polypyrrole-ABTS-pyrene in Figure 2.8c. While ABTS is a commonly used MET mediator for ORR enzymes, Dr Elouarzaki and colleagues showed that the pyrene group is able to orient towards the single Cu active site in laccase to minimise the enzyme-electrode distance, possibly via its adjacent hydrophobic binding pocket (shown in blue in Figure 2.8b), so as to enhance the MET from ABTS to laccase. It is worth mentioning that such an orientation design is generally applied in conjunction with the DET mechanism. The other terminal group in this electron transfer system, the polypyrrole conducting polymer, provides an anchoring site for immobilisation on MWCNTs and also helps transfer electrons from the electrode to ABTS. This triple-combination approach with multiple functions differs from the conventional DET and MET strategies, which usually just have one of these functions.

Dr Elouarzaki prepared pyrrole-ABTS-pyrene monomers through a step-by-step chemical connection of N-(3-aminopropyl) pyrrole, ABTS and pyrene methylamine molecules. Then, a polypyrrole-ABTS-pyrene film was successfully synthesised by a simple electropolymerisation of the pyrrole part of those monomers. The BFC electrode was subsequently made by immobilising laccase. The mass of deposited laccase on the modified MWCNT/polypyrrole-ABTS-pyrene surface was calculated to be around 5.8×10^{-7} g cm^{-2} , which considerably exceeded that obtained from previous methods such as physical adsorption and π - π stacking.

Using the MWCNTs/polypyrrole-ABTS-pyrene/laccase bioelectrode in a half cell, Dr Elouarzaki demonstrated that the maximum ORR current density reached 2.45 mA cm^{-2} . In contrast, when laccase was just physically adsorbed at, oriented towards or connected via a conventional MET mediator to the MWCNT surface, the maximum current densities were found to be about 0.6, 2.0 and 1.4 mA cm^{-2} , respectively. Impressively, the MWCNTs/polypyrrole-ABTS-pyrene/laccase bioelectrode maintained 50% of the initial ORR current even after 120 days. Note that a complete loss of ORR activity after 80 days was observed for a MWCNTs/polypyrrole-ABTS/laccase bioelectrode, highlighting the importance of the orientation effect offered by pyrene. Dr Elouarzaki and co-workers further demonstrated that in a proton exchange membrane hydrogen-air BFC, the MWCNTs/polypyrrole-ABTS-pyrene/laccase biocathode provided a high power density of 7.9

mW cm^{-2} at room temperature, which outperforms most BFCs reported in the literature.

Dr SUN Libo (Research Fellow, NTU) expanded the idea of using macrocyclic ligand into exploiting heterocyclic structure for CO_2 reduction. One may find that for both porphyrin and phthalocyanine, the common characteristic is the 18 π -electrons, planar and continuous four-ring conjugated structure containing four pyrrole subunits. Similarly, the ligand H_2CPY prepared here is a structure containing four pyridine subunits. The pyridine subunits in the molecular could also form similar highly delocalised heterocyclic conjugated aromatic macrocyclic structure. The delocalised π -electrons may help lower the total energy of the system and get a much more stable geometry. When coordinated with cobalt salt, the Co(II)CPY complex formed was directly immobilised onto CNT via π - π interaction to form a Co(II)CPY/CNT composite catalyst. Such a method has been commonly used nowadays in facile screening effective electrocatalysts for heterogeneous CO_2 reduction and thus no further functionalisation of the ligand is required. Interestingly, the Co(II)CPY prepared indeed exhibits excellent catalytic activity for electrolysis CO_2 reduction to CO at relatively suitable overpotential at water media. Considerable current densities, turnover frequencies and stabilities can be obtained over a wide overpotential range. Such promising properties prompted us to investigate and interpret further about this kind of pyridine subunits containing ligand.

Fig. 2.9: **a** FE distribution of Co(II)CPY/CNT with 2.5 % mass loading. Inset shows FE at -0.55 V and -0.60 V vs. RHE for other kinds of mass loading, all exhibit excellent CO selectivity. **b** FE distribution of Co(II)CPY/CNT with 2.5 % mass loading at different KHCO_3 concentrations. Inset shows FE at -0.50 V and -0.55 V vs. RHE , the FE of CO is highly correlated with electrolyte concentration, and at least should above 0.1 M KHCO_3 to reach above 90 % CO selectivity at -0.50 V vs. RHE , but could reach above 90 % CO selectivity at -0.50 V vs. RHE . **c** Partial current density for CO . **d** The proposed mechanism.

Dr SUN Libo

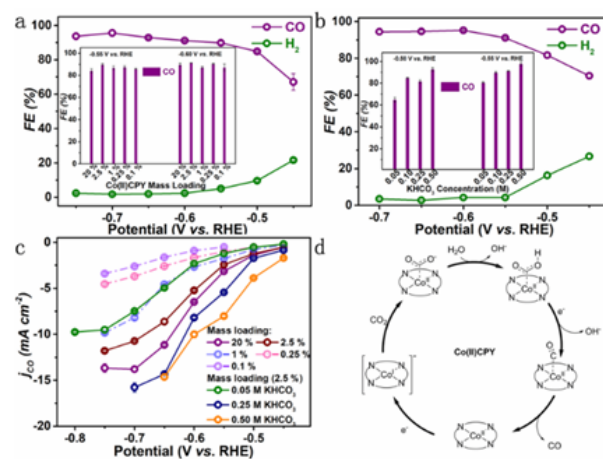

Update on work package 2.3

Electrochemical reactor engineering: cogeneration and electro-synthesis

ZHANG Shengliang (PhD student, NUS) is interested in the design and preparation of nanocrystals as the active component of spectrally-selective electrochromic smart windows. His recent work was focused on the study of Al^{3+} intercalation/de-intercalation-enabled dual-band electrochromism. He presented a dual-band electrochromic smart window design using the intercalation/de-intercalation of Al^{3+} cations to substitute for the conventional use of monovalent cations in electrochromic applications. The Al^{3+} intercalation/de-intercalation-enabled electrochromic smart window delivered not only an efficient and independent control of NIR and VIS light transmittance, but also an impressive electrochromic performance – high optical modulation of the full solar spectrum, high coloration efficiencies, fast switching times, and high bistability and cyclability. In addition, the use of Al^{3+} is cost-effective (Al is earth abundant) and environmentally responsible, and it also circumvents the application issues of some common monovalent cations such as the corrosiveness of H^+ , the high cost of Li^+ and the large radius of Na^+ . Most importantly, the efficient diffusion of Al^{3+} in oxygen-deficient monoclinic tungsten oxide nanowires (m-WO_{3-x} NWs; as good as that of Li^+) and a shallow intercalation/de-intercalation depth of Al^{3+} (due to three-electron instead of single-electron redox reactions)

have significantly improved the switching time and cycle stability of m-WO_{3-x} NW in dual-band electrochromic applications. The performance of Al^{3+} intercalation/de-intercalation-enabled dual-band electrochromism was also verified in laboratory prototypes. He has published this work in *Energy & Environmental Science*.

Dr ZHANG Tianran's (Research Fellow, NUS) main research interest lies in the development of low-cost electrocatalysts for the oxygen reduction reaction (ORR) and oxygen evolution reaction (OER). Recently, he discovered that manganese oxide based oxygen electrocatalysts can be rendered noble metal-like by combining phosphate-modifications with hollow nanostructures. He developed a simple and room temperature scalable self-templating method with phosphate-mediated Mn redox reactions. A series of simple ($\text{h-MnO}_x\text{Py}$) and complex phosphated manganese oxide ($\text{h-Me-MnO}_x\text{Py}$, Me = Co, Ni, Cu) hollow nanospheres could be formed this way. This method is more efficient than conventional hollow nanostructure construction techniques based on hard and soft templates and hydrothermal Ostwald ripening. Among the hollow phosphated manganese oxides, $\text{h-MnO}_x\text{P0.21}$ showed the best OER performance (similar to 20wt% Pt/C) and $\text{h-Co-MnO}_x\text{P0.21}$ showed the best OER performance

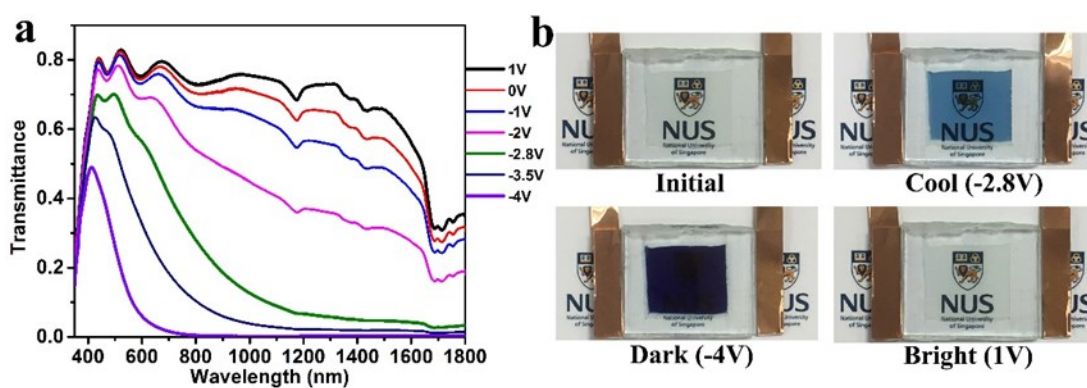

Fig. 2.10: **a** Optical transmittance spectra. **b** Digital photos of a dual-band electrochromic device.

ZHANG Shengliang

Fig. 2.11: 1,10-phenanthroline-Cu complex on a mesostructured graphene matrix.

Dr WANG Jiong

(marginally higher than 20wt% Ir/C). Good application performance was demonstrated in both alkaline and neutral rechargeable Zn-air full cell batteries where these catalysts were used in tandem.

Dr WANG Jiong (Research Fellow, NTU) reports that a structurally simple molecular 1,10-phenanthroline-Cu complex on a mesostructured graphene matrix can be active and selective toward CO₂ reduction over H₂ evolution in an aqueous solution. The active sites consisted of Cu(I) centre in a distorted trigonal bipyramidal geometry, which enabled the adsorption of CO₂ with η¹-COO-like configuration to commence the catalysis. Using *in situ* infrared spectroelectrochemical investigation, we demonstrated that the Cu complex was reversibly heterogenised near graphene surface via potential control. An increase of electron density in the complex was observed as a result of the interaction from the electric field, which further tuned the electron distribution in the neighbouring CO₂. It was also found that the mesostructure of graphene matrix favoured CO₂ reduction on the Cu centre over hydrogen evolution by limiting mass transport from the bulk solution to the electrode surface.

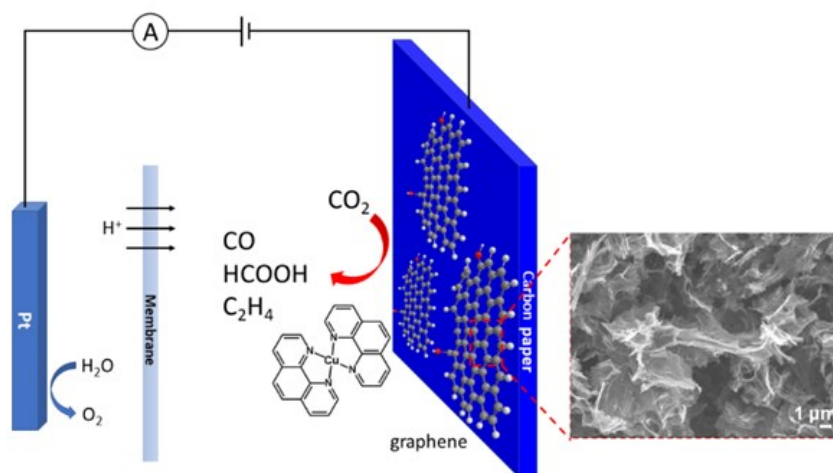

Dr CAO Sheng (Research Fellow, NUS) is interested in dual-band electrochromic materials and devices based on metal-doped TiO₂ nanocrystals (NCs) which support the selective modulation of infra-red (NIR) and visible light (VIS) transmissions. He used a fluoride-assisted synthesis to produce high uniformity aliovalently-doped anatase TiO₂ NCs with strong plasmonic absorption in the NIR region and an overall good dual-band electrochromic performance. He selected Ta-doped TiO₂ NCs as the model system and investigated the independent tunability of their NIR and VIS electrochromic performance in detail. His spectroscopic investigations revealed that the material optical response in the NIR region is plasmonic-based and may be attributed to the substitution of Ta⁵⁺ on Ti⁴⁺ sites resulting in the generation of free carriers in the conduction band of the TiO₂ NCs. These doped plasmonic NCs showed a high dynamic range for visible and NIR light modulation (up to 86.3% at 550 nm and 81.4% at 1600 nm); and good electrochemical stability (the transmittance loss at 550nm and 1600 nm was 1.3% and 6.7% respectively after 2000 cycles) in three-electrode measurements. His ongoing work will focus on the fabrication of multifunction electrochromic devices based on these doped TiO₂ NCs and the characterisation of their performance.

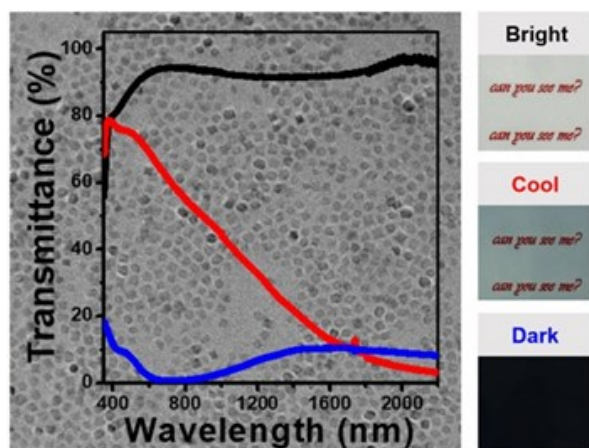

Fig. 2.12: Fluoride-assisted synthesis of plasmonic colloidal Ta-doped TiO₂ nanocrystals for near-infrared and visible-light selective electrochromic modulation.

Dr CAO Sheng

Scientific output

The following are some examples of CREATE-acknowledgement papers generated by IRP2 during the reporting period. A full list of publications may be found on page 87.

Al³⁺ intercalation/de-intercalation-enabled dual-band electrochromic smart windows with a high optical modulation, quick response and long cycle life

Shengliang Zhang, Sheng Cao, Tianran Zhang, Adrian Fisher and Jim Yang Lee

DOI: 10.1039/C8EE01718B

Abstract: Dual-band electrochromic smart windows with independent control of the transmittance of near-infrared (NIR) and visible (VIS) light can contribute significantly to the reduction of building energy consumption. Cost and inadequate electrochromic performance are the current technical challenges. We present here a dual-band electrochromic smart window design based on the intercalation/de-intercalation of Al³⁺ cations to replace the common use of monovalent cations in electrochromic applications. The Al³⁺ intercalation/de-intercalation-enabled electrochromic smart window delivers not only efficient and independent control of NIR and VIS light transmittance, but also impressive electrochromic performance – a high optical modulation of the full solar spectrum (93.2%, 91.7%, 88.5%, and 86.8% at 633, 800, 1200, and 1600 nm, respectively), high

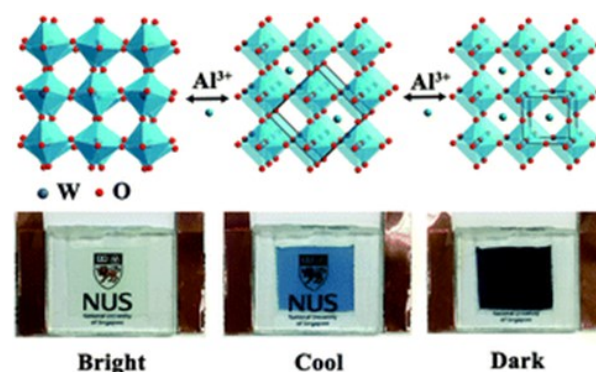

coloration efficiencies (254 and 121 cm² C⁻¹ at 1200 and 633 nm, respectively), fast switching times (8/5 s and 16/13 s at 1200 and 633 nm, respectively, for colouration/bleaching), and high bistability and cyclability (a 5.5% capacity loss after 2000 cycles). The good electrochromic performance can be attributed to the effective diffusion of Al³⁺ in the electrochromic material (as good as that of Li⁺); and a shallow intercalation/de-intercalation depth enabled by the ability of Al³⁺ to support three-electron redox reactions. The performance of Al³⁺ intercalation/de-intercalation-enabled dual-band electrochromism was also verified in laboratory prototype devices to confirm its suitability for dual-band smart windows.

An electron deficiency strategy for enhancing hydrogen evolution on CoP nano-electrocatalysts

Hanbin Liao, Yuanmiao Sun, Chencheng Dai, Yonghua Du, Shibo Xi, Fei Liu, Linghui Yu, Ziyu Yang, Yanglong Hou, Adrian Fisher, Shuzhou Li, and Zhichuan Xu

DOI: 10.1016/j.nanoen.2018.05.060

Abstract: Optimising the hydrogen adsorption on electrodes is one of the most effective strategies to promote the hydrogen evolution reaction (HER). In recent years, cobalt phosphides (CoP) have been identified as a promising catalyst for HER in acid. However, the hydrogen adsorption on CoP is strong and a considerable overpotential has to be applied to enable HER. Here, we report a strategy to weaken the hydrogen adsorption on CoP through an electron deficiency in CoP induced by Au@CoP core/shell structure. A weakened hy-

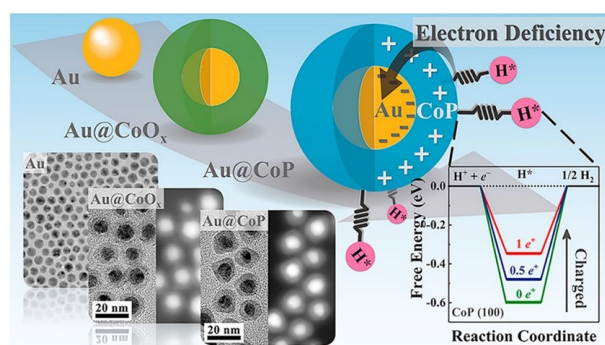

drogen adsorption is confirmed by the density functional theory (DFT) calculation. Au@CoP gave an overpotential (η) of 160 mV at the current density of 1 mA cm⁻²CoP, which is about 50 mV less than pure CoP. It also exhibited a turn-over frequency (TOF) value of 0.68 s⁻¹ per active site at $\eta = 150$ mV, which is more than four times higher than CoP. The strategy reported here holds potential to be extended to other electrodes for optimising their hydrogen adsorption for HER.

Fluoride-Assisted Synthesis of Plasmonic Colloidal Ta-Doped TiO₂ Nanocrystals for Near-Infrared and Visible-Light Selective Electrochromic Modulation

Sheng Cao, Shengliang Zhang, Tianran Zhang and Jim Yang Lee

DOI: 10.1021/acs.chemmater.8b02196

Abstract: Dual-band electrochromic materials are integral to the development of smart windows where visible and near-infrared (NIR) light transmittance may be individually controlled. We present here colloidal Ta-doped TiO₂ anatase nanocrystals (NCs) as a promising candidate and their preparation by a fluoride-assisted synthesis method. The dual-band electrochromic performance of these NCs may be credited to their strong localised surface plasmon resonance (LSPR) absorption in the NIR region. The Ta doping of the TiO₂ NC host, which has not been attempted before, is made easy in the presence of the fluoride anions. The synthesis produces Ta-doped TiO₂ NCs as a highly uniform colloidal solution. Spectroscopic measurements indicate the generation of free car-

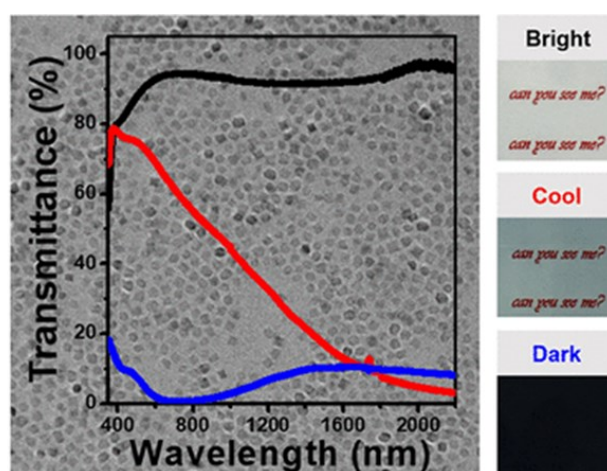

riers in the TiO₂ conduction band by the Ta⁵⁺ substitution of Ti⁴⁺ cations as the origin of the LSPR. Good dual-band electrochromic performance in terms of a high dynamic range for visible and near-infrared light modulation (86.3% at 550 nm and 81.4% at 1600 nm) and good electrochemical stability (the optical modulation at 550 and 1600 nm decreased by 1.3% and 6.7%, respectively, after 2000 cycles) were demonstrated in three-electrode cells to suggest Ta-doped TiO₂ NCs as a promising new electrode material for smart windows.

Metal-doped TiO₂ colloidal nanocrystals with broadly tunable plasmon resonance absorption

Sheng Cao, Shengliang Zhang, Tianran Zhang, Adrian Fisher and Jim Yang Lee

DOI: 10.1039/C8TC00185E

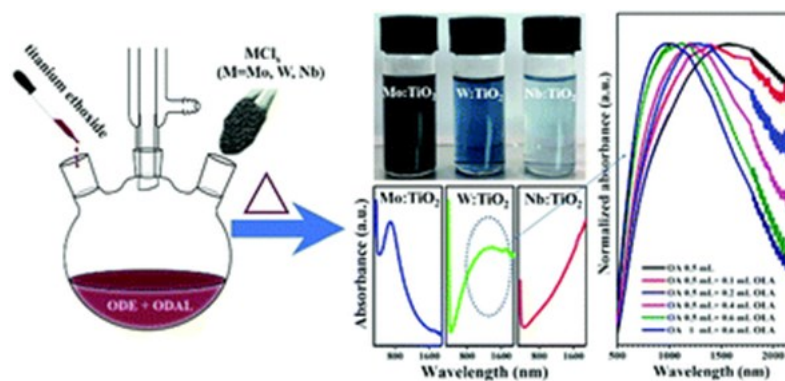

Abstract: We report here the discovery of metal-doped colloidal TiO₂ nanocrystals (NCs) with broadly tunable plasmon resonance absorption; and their synthesis by a facile and scalable one-pot method. A strong localised surface plasmon resonance (LSPR) absorption peak occurs in the as-synthesised Mo, W, and Nb-doped TiO₂ NCs in the visible, near-infrared (NIR) and mid-infrared regions respectively. Density functional theory calculations indicate a dopant perturbation of the TiO₂ electronic structure and the resultant increase in the electron density

at the Fermi level as the likely cause for the strong LSPR absorption. The W-doped TiO₂ NCs are the most versatile since their LSPR absorption in the NIR region can be varied from 980 to 1700 nm by tailoring the dopant concentration and the NC morphology. The method of synthesis can also be scaled up to gram-level production in batch reactors. Tunable LSPR properties and the ease and scalability of synthesis are the strong features of these metal-doped TiO₂ NCs for plasmonic applications.

In situ formation of molecular Ni-Fe active sites on heteroatom-doped graphene as a heterogeneous electrocatalyst toward oxygen evolution

Jiong Wang, Liyong Gan, Wenyu Zhang, Yuecheng Peng, Hong Yu, Qingyu Yan, Xinghua Xia and Xin Wang

DOI: 10.1126/sciadv.aap7970

Abstract: Molecularly well-defined Ni sites at heterogeneous interfaces were derived from the incorporation of Ni²⁺ ions into heteroatom-doped graphene. The molecular Ni sites on graphene were redox-active. However, they showed poor activity toward oxygen evolution reaction (OER) in KOH aqueous solution. We demonstrated for the first time that the presence of Fe³⁺ ions in the solution could bond at the vicinity of the Ni sites

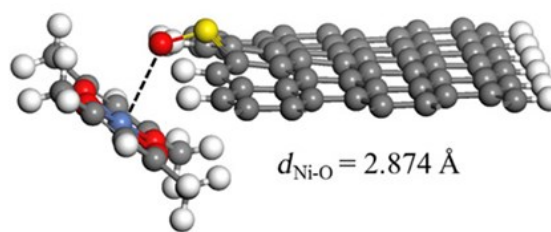

with a distance of 2.7 Å, generating molecularly sized and heterogeneous Ni-Fe sites anchored on doped graphene. These Ni-Fe sites exhibited markedly improved OER activity. The Pourbaix diagram confirmed the formation of the Ni-Fe sites and revealed that the Ni-Fe sites adsorbed HO⁻ ions with a bridge geometry, which facilitated the OER electrocatalysis.

Other activities and achievements

Dr Chencheng DAI gave an oral presentation at the 2018 International Symposium on Electrocatalysis and Electrosynthesis in Hunan, Changsha, China with the title “Electrochemical production of lactic acid from glycerol oxidation catalysed by AuPt nanoparticles.” Dr Dai, Dr Adrian Fisher and Prof Zhichuan XU also presented a poster with the same title.

Dr Kamal Elouarzaki and colleagues’ recently published paper "Coupling orientation and mediation strategies for efficient electron transfer in hybrid biofuel cells" was advertised on several scientific websites, such as:

<https://www.nature.com/articles/s41560-018-0183-3>

<https://phys.org/news/2018-06-electron-enzymatic-biofuel-cells.html>

<https://physicsworld.com/a/improving-electron-transfer-in-enzymatic-fuel-cells/>

Dr Sheng CAO attended The 13th International Meeting on Electrochromism, Chiba (Japan), 27-31 August, 2018 and presented a poster on “Metal-doped TiO₂ Colloidal Nanocrystals with Broadly Tunable Plasmon Resonance Absorption”.

Shengliang Zhang attended The 13th International Meeting on Electrochromism in Chiba, Japan, 26-31 August, and presented an oral paper on “Monoclinic Oxygen-Deficient Tungsten Oxide

Nanowires for Dual-Band Electrochromic Smart Windows”.

Dr Kuppa Ashoke Raman conducted a workshop on the mathematical modelling of electrochemical reactors for eCO₂EP members in June. The workshop also included PhD students from NTU and NUS. To begin with, the basics of mathematical modelling and the working of a software package were explained. The lecture was followed by a hands-on session on modelling basic flow systems using COMSOL. Next, a seminar on the basics of electrochemistry and its modelling was given, followed by another hands-on session on modelling electrochemical cells.

Vishvak Kannan won third prize in the Metrohm Singapore Young Chemist Award (image below).





IRP3: CAPRICORN

CARBON ABATEMENT IN THE PETROLEUM REFINING INDUSTRY: A CONTROL AND OPTIMISATION RESEARCH NETWORK

CAPRICORN aims at answering the question of how to minimise CO₂ emissions while optimally running a modern industrial park including complex refinery operations to produce downstream fuel blends. The research uniquely combines and advances the state-of-the-art in low carbon research encompassing fields of surrogate modelling, fuel blending using nonlinear correlations, fuel-engine mapping for emissions regulation compliance, inorganic and organic nanoparticle flame synthesis. Uncertainty propagation, Bayesian parameter estimation, dynamic optimisation of refinery operations and associated energy loads, and model predictive control are methods used to develop sustainable low-carbon refinery operations.

CAPRICORN is led by PIs:

Prof. Markus Kraft (CAM)

Prof. Raymond LAU Wai Man (NTU)

Prof. Iftekhhar Karimi (NUS)



OVERVIEW

Since April this year, the J-Park Simulator (JPS) has been extended with new functionalities to further increase its degree of autonomy and intelligence. For example, we have incorporated an automated arbitrage spotter agent that searches for opportunities to make additional profit by analysing the futures market prices for both reagents and products, while taking into consideration the cost of storage and production derived from simulations of a chemical process. Secondly, we have developed a prototype for a semantic web service composition based on the semantic structure of the Minimal Service Model (MSM) ontology. The motivation of this prototype is to demonstrate the automated construction of more complex agents via the integration of simpler agents for a specified set of conditions. This is an imperative step in achieving higher degree of autonomy, intelligence and collaboration among agents. Thirdly, we have also integrated an agent that identifies the optimal mass exchange network configuration with the objective of minimising the overall network cost based on considering the characteristics of the companies within the network. Lastly, we have included an agent which analyses the cost-effectiveness of decarbonisation technologies for different technology learning rates and carbon prices.

We are currently further developing the semantic web service composition and agent service composition prototypes in order to enhance their functionalities. We are also investigating the integration of OntoChem, an ontology for chemical kinetics mechanisms, *i.e.* species and reactions,

into the JPS to demonstrate the multi-domain and hierarchical capabilities of the JPS.

In C4T Phase 2, the J-Park Simulator will become a new overarching IRP. The aims of IRP JPS are to work with the other IRPs to integrate domain-specific models and knowledge developed within the programme and to identify the most promising research areas. We intend to achieve these aims by combining fundamental research with the latest advances in semantic web technologies and ideas from Industry 4.0.

In the laboratory, we have continued to build upon our capabilities to synthesise functional inorganic nanostructured materials. For example, we have been working to improve the effectiveness of flame-synthesised TiO₂ for photocatalytic hydrogen generation. We have been able to show that, by using the less well-studied srilankite phase of TiO₂ together with a platinum co-catalyst, it is possible to significantly enhance the hydrogen generation rate.

Prof. Markus Kraft, PI
University of Cambridge

Update on work package 3.1

Industrial network model of Jurong Island—process flow sheets: energy and material

Over the past six months, Leonardus Kevin Aditya (Project Officer, NTU) has extended the ontology used in the J-Park Simulator for the domains of agents so that the agents themselves have their own description and can be connected one another using the ontological relations semantically. In addition, a power systems domain (OntoPowSys) ontology was also created together with Dr Rémy Rigo-Mariani (Research Fellow, NTU, IRP4) to represent power flow systems from a general electrical perspective to replace an older version, and standardise the IRIs of all the ontology and knowledge bases available based on the domain category. Some applications also have been developed like features that are related to the mass exchange network applied in an eco industrial park so that the optimised flow of material between every company can be established. Then, more case studies related to the ADMS dispersion model are also developed that involve the buildings surrounding the source to see how these buildings affect the dispersion pattern, specifically in the cases of Berlin and The Hague.

NG Wei Ern (Software Developer, CARES) is currently working on the integration of a carbon emissions model produced by ZHANG Chuan (PhD student, NTU) as part of a power plant decarbonisation feasibility analysis into the JPS. The model estimates the amount of carbon emitted by power plants around the world. It will eventually be integrated into a system that displays a bubble chart reflecting the power plants involved in the estimation model.

Dr Andreas Eibeck (Senior Research Fellow, NTU) is responsible for the overall architecture of the JPS and has been working on several steps to drive the JPS forward to a plug-in architecture. The semantic layer of the JPS consists of data and information from different domains that can be regarded as a connected distributed knowledge graph. Dr Eibeck recently studied some aspects of how to annotate and integrate external data into the knowledge graph. He formalised the idea of agents as building blocks in the JPS. Agents are software modules that can interact with each other and operate on the JPS knowledge graph. Together with the JPS team, he introduced an agent ontology to describe the interface of each agent in a semantic way. These semantic descriptions allow establishment of an agent discovery in the JPS that makes the communication between agents more flexible. They also serve as starting point for automatic composition of agents which was realised by ZHOU Xiaochi (Software Developer, CARES).

As a software architect, Dr Eibeck was strongly involved in all development activities of the JPS team including backlog refinement, software design and implementation. In collaboration with the JPS team, he developed guidelines concerning structuring ontologies and knowledge bases, writing clean and maintainable code, and concerning the communication between agents.

Fig 3.1: Sensitivity of levelised cost of electricity of natural gas combined cycle.

ZHANG Chuan

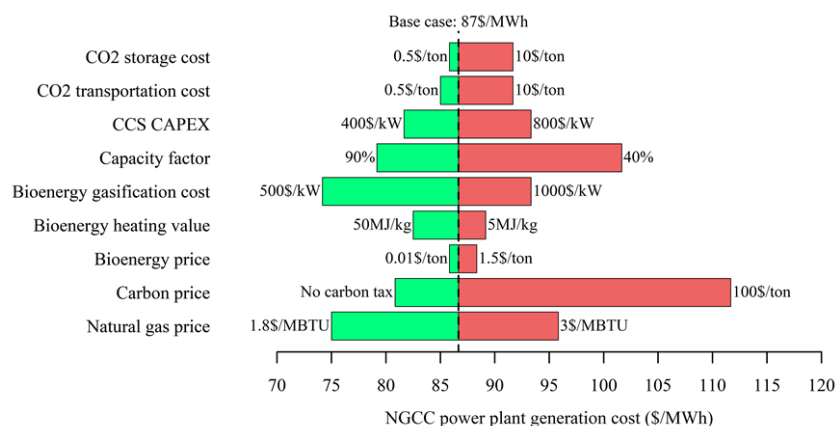

Update on work package 3.2

Link of refinery products with engine operations—surrogate fuels: model and experiments

Jacob Martin (PhD student, CAM) has been continuing to consider the formation of soot in flames and the impact of polar aromatic species in the nucleation of aromatics to form the first nanoparticles. He presented this new mechanism at a talk at the 37th International Symposium on Combustion, which was also published as a paper in *Proceedings of the Combustion Institute*: "Polar curved polycyclic aromatic hydrocarbons in soot formation". This paper detailed the smallest size an aromatic can be before becoming curved by pentagon integration and therefore polar. This aids in understanding how early in a flame polar aromatics will be relevant. Jacob also found the binding energy of moderately curved aromatics to be comparable to their planar cousins, which indicates they are still able to cluster effectively. The paper also suggested the potential interaction that could occur between polar PAH and the many charges that exist in the flame. Following up on the work presented at the conference, Jacob has just recently published a new paper "Flexoelectricity and the Formation of Carbon Nanoparticles in Flames". This paper provides evidence for the presence of a large number of polar aromatics in flames. The researchers were able to sample early soot nanoparticles from a diffusion flame and image these nanoparticles using electron microscopy, which showed that the majority of the fringes in the early soot particles

were curved. The polarity of a representative curved PAH was found to be two to three times that of water (5.32 D), suggesting a considerable charge polarisation. This charge polarisation leads to a strong interaction between the positively charged species in the flame and the curved aromatic, which they explored with simulations and found binding energies strong enough to stabilise clusters at flame temperatures. This provides for the first time an explanation for the electrical aspects for soot formation, such as the ability of an electric field to stop soot formation, and could lead to new methods for reducing harmful emissions from engines.

Angiras Menon (PhD student, CAM) has continued investigating the use of optical properties to characterise the physiochemical properties of soot and study the precursors of these carbonaceous nanoparticles. This work has involved the computation of optical band gaps (OBGs) of polycyclic aromatic hydrocarbons (PAHs), the precursors to the formation of carbonaceous nanomaterials in flames. In particular, this has focused on the optical properties of more complicated PAHs, such as PAHs with aliphatic linkages, curved PAHs of a variety of sizes and geometries, and PAHs containing radical sites. Comparison to previous OBGs measured experimentally in flames by Dr Maria Botero (Research Fellow, NUS) has suggested that smaller curved PAHs and aliphatic

Fig 3.2: Electric potential around a curved aromatic molecule found in early soot nanoparticles.

Jacob Martin

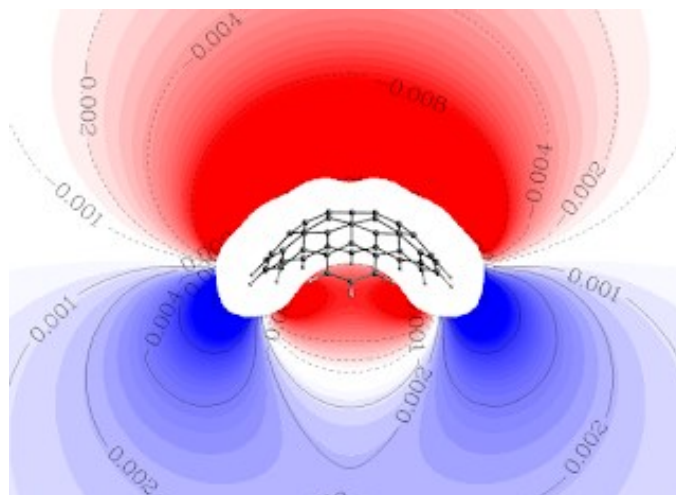

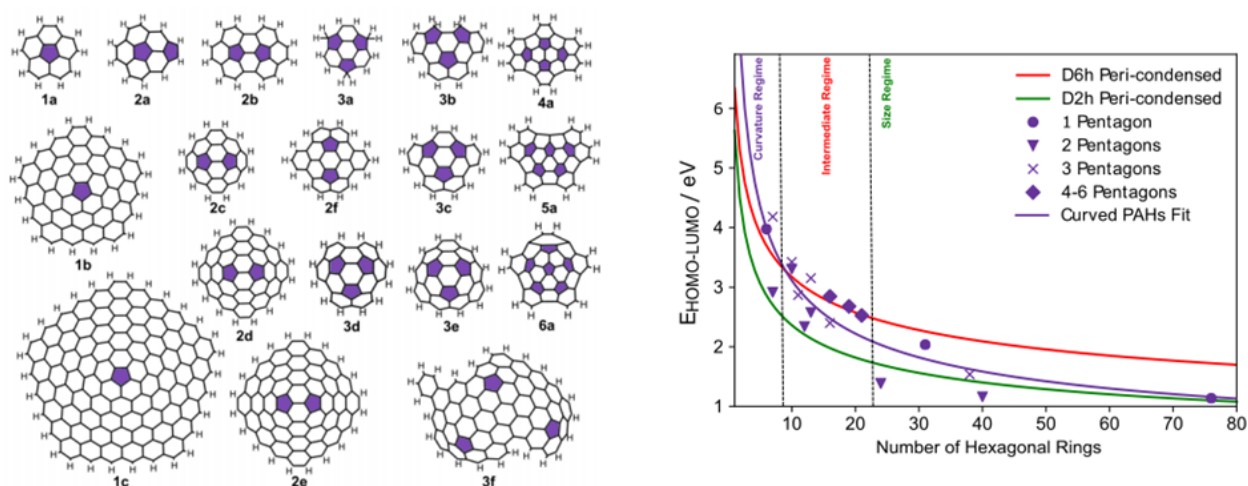

Fig 3.3: Comparison of the optical properties of curved PAHs to flat PAHs across a large size range. The molecular drawings on the left are adopted from: Martin et al., *J. Phys. Chem. C*, 2017 121, 48, 27154-27163.

Angiras Menon

linkages could be playing a role in the formation of soot in flames. This work is being prepared for publication and was also presented as a poster at the 37th International Symposium on Combustion in Dublin in August. Further to this, the reaction pathways by which curved PAHs are formed in flames are also being investigated. This work involves using density functional theory (DFT) calculations to investigate how aliphatic bond formation and condensation reactions between small PAHs can lead to the formation of moderately sized curved PAHs. The aim is to incorporate

such reactions into existing chemical mechanisms and the group's kinetic Monte Carlo code so that a more complete description of combustion chemistry can be achieved.

During the last six months, WU Shaohua (PhD student, NUS) has been working on the reconstruction of a particle size distribution from its moments. He has studied several reconstruction techniques such as maximum entropy, extended quadrature method of moments and reconstruction with a presumed function. He has tested

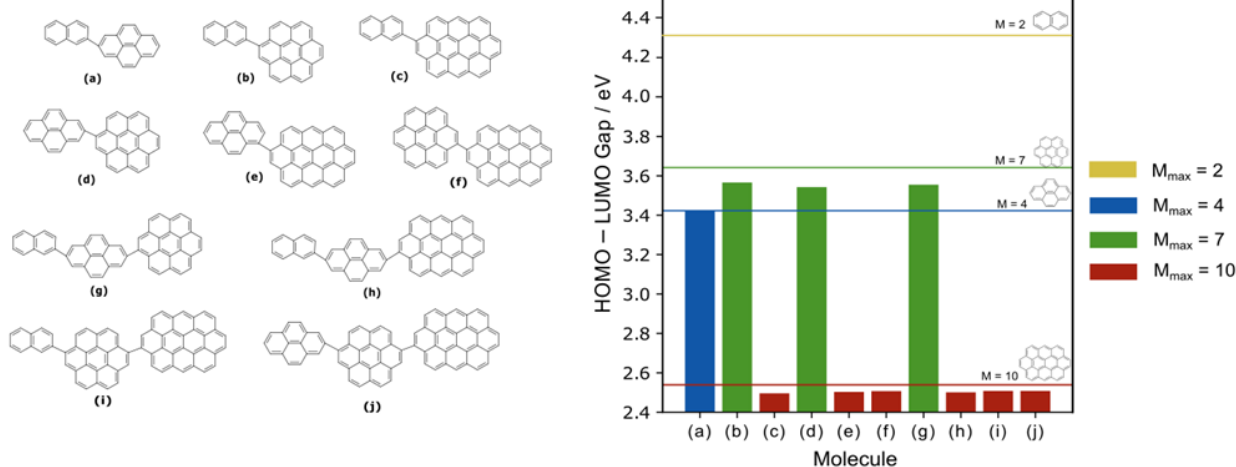

Fig 3.4: Comparison of the optical properties of cross-linked PAHs to their constituent PAHs for a variety of arrangements and constituent PAHs.

Angiras Menon

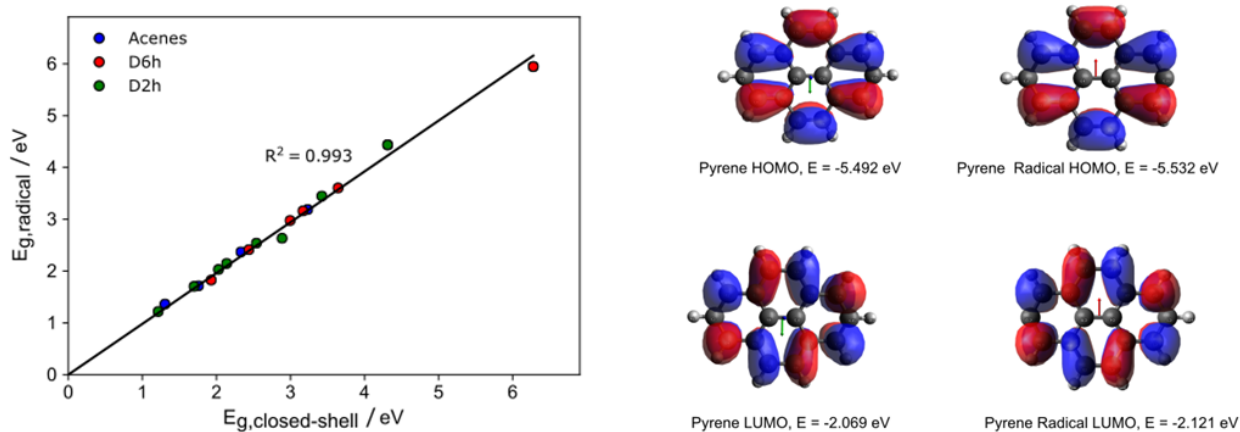

Fig 3.5: Comparison of the optical properties of PAHs containing radical sites to the closed-shell PAHs of the same size. The preservation of the carbon backbone results in optical indifference between the radical and closed-shell PAHs.

Angiras Menon

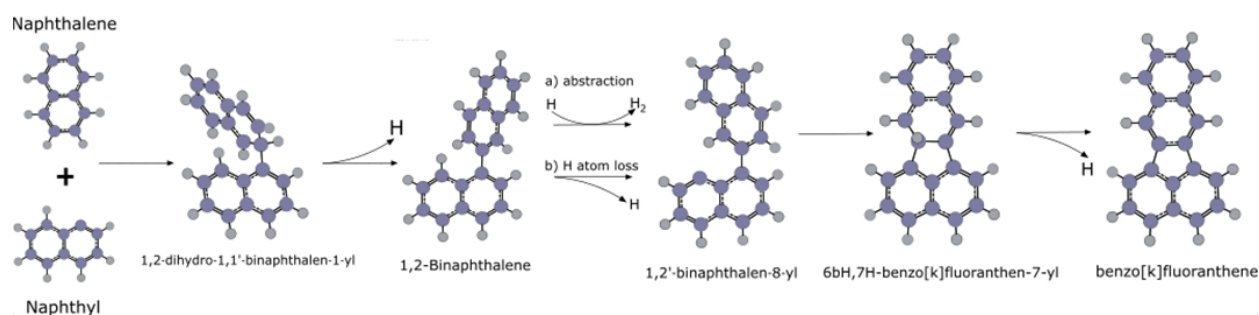

Fig 3.6: Reaction pathway for the formation of benzo[k]fluoranthene from a naphthalene and naphthyl radical. This pathway illustrates how aliphatic bridging and condensation reactions allow small PAHs to form a larger PAH with a pentagon. This is a route that leads to the formation of curved PAHs.

Angiras Menon

these methods extensively with a number of cases and tried to improve the reconstruction performance for the maximum entropy method, then implemented the method into an engine combustion simulation tool as a post-processing method to reproduce the soot particle size distribution based on the obtained moments, so that a comprehensive understanding of the soot particle dynamics inside a diesel engine cylinder can be achieved. One paper based on this entitled "Comparison of methods for reconstructing a particle size distribution from its moments" has been developed. Besides this, Shaohua has worked on automatically calibrating soot model parameters for the simulation of soot formation and oxidation in internal combustion engines. A paper about this topic is under preparation. In the meantime, he has finished and submitted his PhD

thesis "Numerical study of soot formation and oxidation processes".

The experimental efforts at the Department of Chemical Engineering and Biotechnology (CEB), University of Cambridge, aim at advancing the understanding of soot formation processes and the synthesis of novel nanostructures for applications in electrochemistry or photocatalysis. In the reporting period, Dr Jochen Dreyer (Research Fellow, CAM) developed and designed a new modular burner system (Figure 3.8) that will be used in C4T Phase 2 to synthesise metal oxides in flames and to deposit them onto various substrates. The burner will also be used for fundamental particle formation studies. A copy of the new burner will be built for the laboratory in Singapore to extend the experimental capabilities

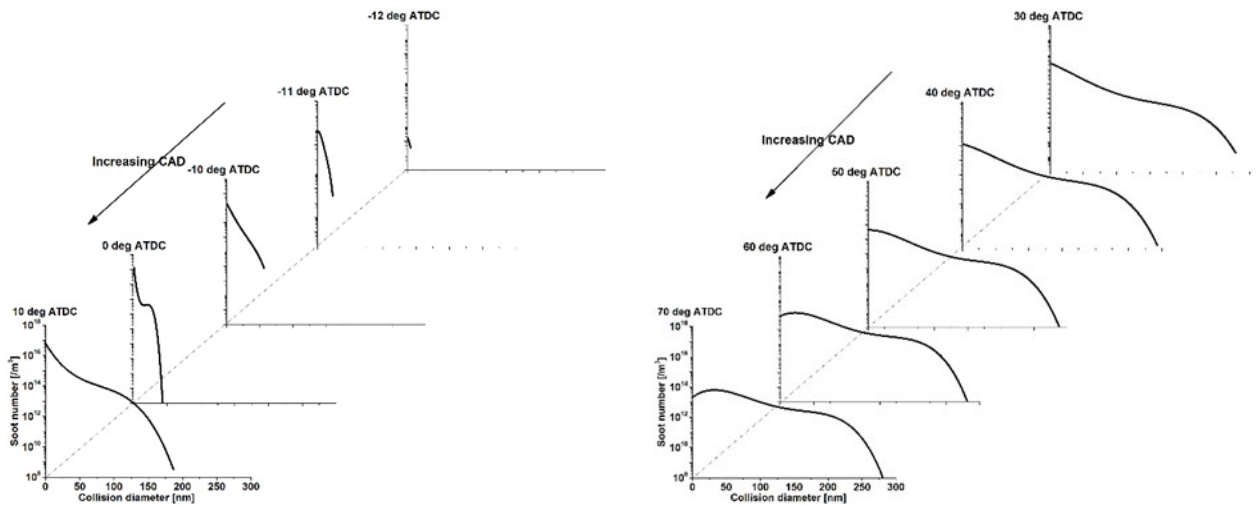

Fig 3.7: The reconstructed soot PSDs using the maximum entropy method as a function of crank angle in diesel engines. **left** The early combustion stage. **right** The late combustion stage.

WU Shaohua

there and to synchronise the experimental work in Cambridge and Singapore.

Besides this, work continued on the investigation of vapour-fed co-flow diffusion flames to elucidate the effect of a fuel’s molecular structure on its sooting propensity. A two-colour pyrometry method was used to obtain 2D soot volume fraction distributions from flame images. One of the key challenges when applying this method is the reconstruction of the 3D cylindrical flame $R(r,z)$

from its 2D projection $P(x,z)$ recorded by the camera (Figure 3.9a). A new method for this reconstruction was developed, which is based on fitting the line-of-sight projection of a predefined intensity distribution (FLiPPID) to the flame images. This new method is capable of obtaining less noisy and more reliable soot volume fractions when compared to other state-of-the-art reconstruction methods, such as BASEX or onion peel-ing with Tikhonov regularisation (Figure 3.9b).

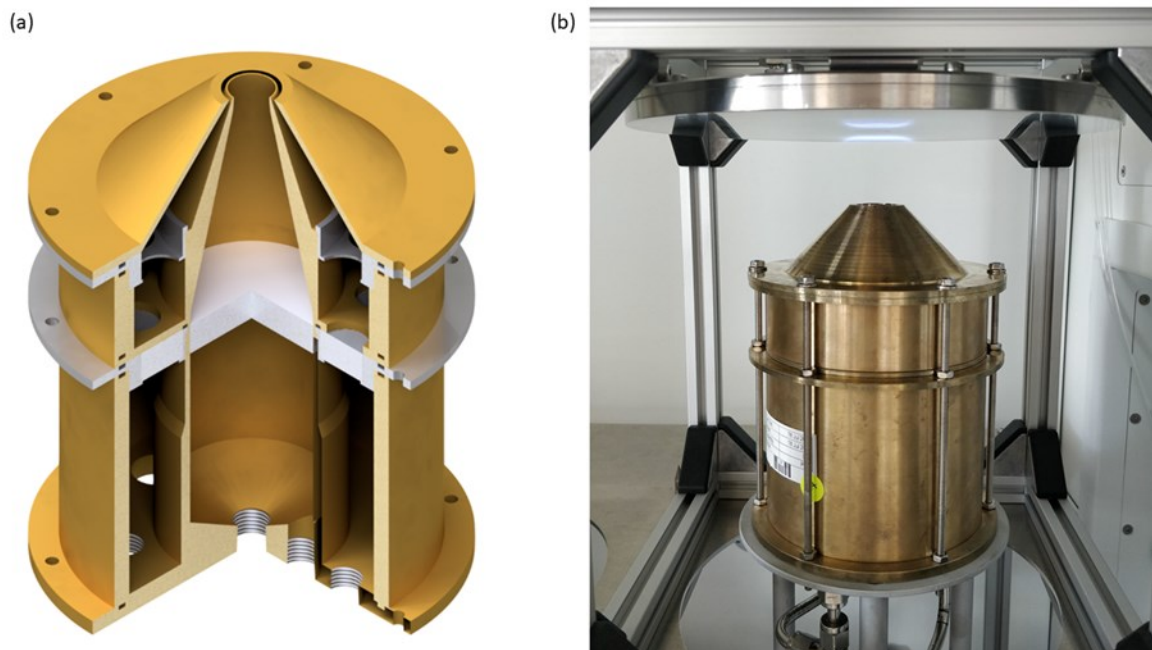

Fig 3.8: **(a)** Rendered image of the newly developed burner system. **(b)** Photograph of the newly developed burner in operation.

Dr Jochen Dreyer

Dr Maurin Salamanca's (Research Fellow, CAM) research aims at elucidating the fundamental processes leading to soot formation during hydrocarbon combustion. Her main interest lies in the study of the soot formation process and the role of biofuels in reducing pollutant formation. Recently, she carried out a systematic study to correlate the fuel structure of cycloalkanes and cycloalkenes and the nanostructure of the soot produced in an *n*-heptane laminar co-flow diffusion flame. The selected fuels (cyclopentane - C_5H_{10} , cyclopentene - C_5H_8 , cyclohexane - C_6H_{12} , cyclohexene - C_6H_{10} and methylcyclohexane - C_7H_{14}) were mainly chosen for the differences in their sooting tendency. The co-flow diffusion flames of the fuel mixtures (*n*-heptane/cyclic fuel) have been stabilised in a Yale burner. The particle size distribution and temperature along the centre line of the flames were measured by Differential Mobility Spectrometry (DMS) and thermocouple, respectively. The addition of the cyclic fuels, except cyclohexane, promote the formation of soot particles at a lower height above the burner, and a more significant effect is observed for cyclic fuels with double bonds. The addition of C5 cyclic fuels promotes the formation of particles, potentially through the fulvene pathway. Raman spectrometry and transmission electron microscopy (TEM) measurements are the next steps. This investigation will support the recent studies of Jacob Martin (PhD student, CAM) who has demonstrated the importance of polar curved polycyclic aromatic hydrocarbons (cPAH) on the soot formation process by employing electronic structure calculations to determine the earliest onset of curvature

integration and the binding energy of curved homodimers.

Also, a preliminary study of the samples gathered from *n*-heptane co-flow diffusion flames has been carried out by using Raman spectroscopy. The samples were collected using a thermophoretic particle collector developed by Dr Jochen Dreyer (Research Fellow, CAM). This study could lead to new insights into the surface of the particles formed in flames.

During the reporting period, Dr Salamanca visited CARES in Singapore to participate in the commissioning of a new Gas-Chromatograph Mass-Spectrometer (GCMS), which will allow for the measurement of stable species in the combustion process of different fuels.

TAN Yong Ren (Project Officer, NUS) has been working to expand the experimental capabilities in the CARES lab. As of now, the CARES lab is able to perform measurements on soot particle size using DMS and gas flame chemical species using the newly acquired GC-MS system. The GC-MS system is able to quantitatively and qualitatively measure C1 to C6 hydrocarbon species. This is beneficial for the data collection to understand the soot suppression properties of fuel additives. The GC-MS system has been tested on the 60% Yale ethylene flame at 15 mm height above the burner. Qualitatively, it was found to exhibit reasonably good results, showing chemical species that would be expected in the flame.

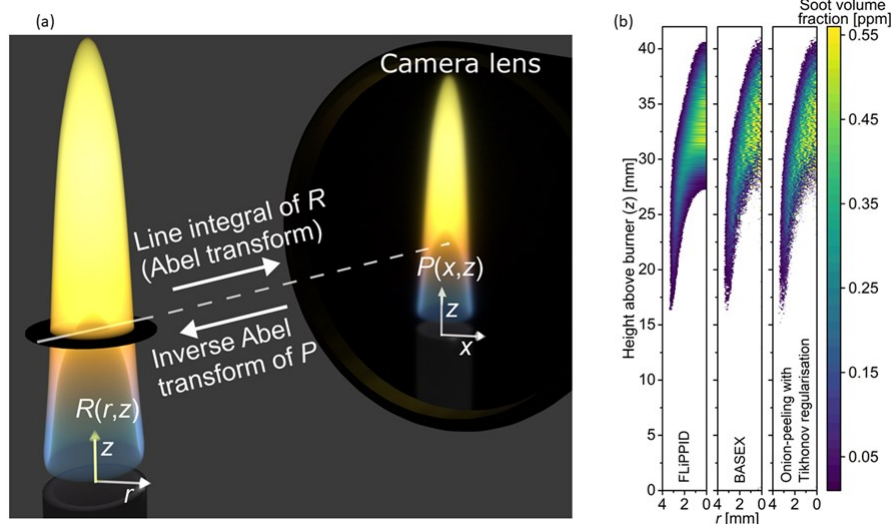
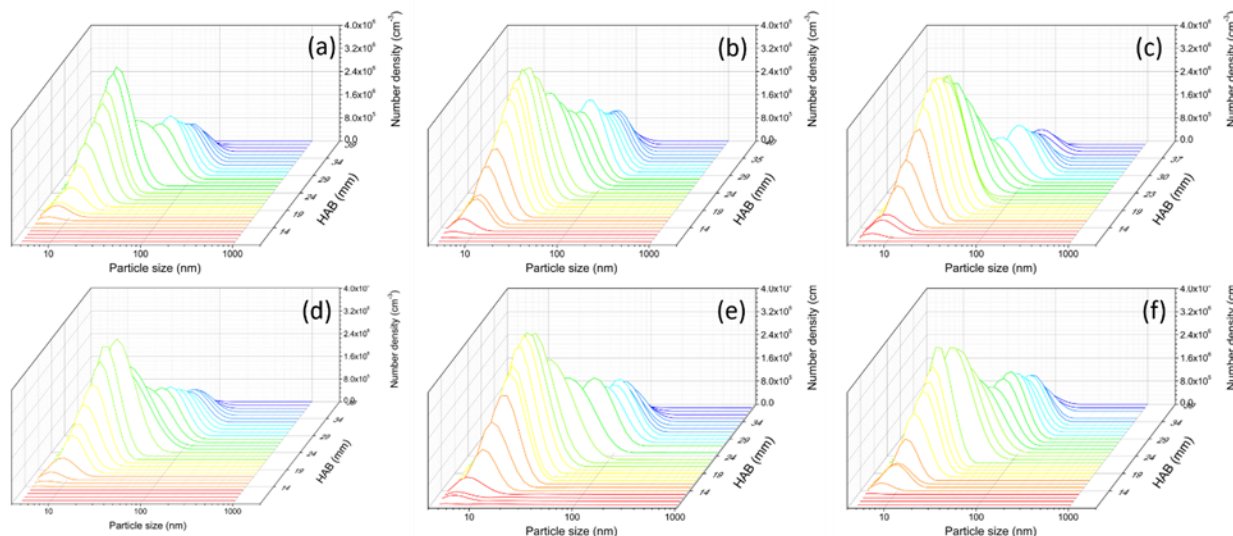

Fig 3.9: (a) Reconstruction of the 3D cylindrical flame $R(r,z)$ from its 2D projection $P(x,z)$ recorded by the camera. (b) BAXEX and onion peeling with Tikhonov regularisation. Dr Jochen Dreyer

Fig. 3.10: Particle size distributions of (a) *n*-heptane, (b) *n*-heptane/cyclopentane, (c) *n*-heptane/cyclopentene, (d) *n*-heptane/cyclohexane, (e) *n*-heptane/cyclohexene, (f) *n*-heptane/methylcyclohexane co-flow diffusion flames. All the mixtures were 80 *n*-heptane/20 cyclic fuel total carbon percentage.

Dr Maurin Salamanca



Dr ZONG Yichen (Research Fellow, NUS) has been developing cutting-edge techniques for the measurement of ultrafine particles (<100 nm) in both combustion processes and the ambient environment. The techniques are based on the mechanism of laser optics, particle dynamics and heterogeneous reactions at the nanoscale. In the combustion process, laser induced incandescence (LII), optical extinction, and two-color pyrometry were performed and calibrated on a diffusion flame first and since extended to different applications, like surrogate fuel property measurements on a smoke point burner and metal oxide nanoparticle synthesis in a stagnation flame. In the ambient environment measurements, short-

lived nucleation events were found prominent in Singapore because of the abundant incoming radiation that enhances the photochemical reactions in the atmosphere. Based on the particle size spectra data, five distinct pollution sources were found as aged traffic and industrial emissions (35%), atmospheric photochemical reactions (13%), fresh traffic emissions (30%), urban background (4%) and fuel combustion (18%). The paper has been submitted to a top environmental science journal and received positive comments. Dr Zong's work has led to the source of PM emissions in Singapore being resolved and identified for the first time based on PNSD data.

Fig. 3.11: Raman spectra of samples collected from *n*-heptane co-flow diffusion flame at (a) 38 mm and (b) 24 mm height above the burner. The spectrum obtained at 38 mm corresponds to mature soot, while the spectrum from the sample at 24 mm corresponded to young soot and adsorbed polycyclic aromatic hydrocarbons. The band observed at 1700 cm^{-1} has been assigned to carbonyl groups; however, further analysis is required to verify it.

Dr Maurin Salamanca

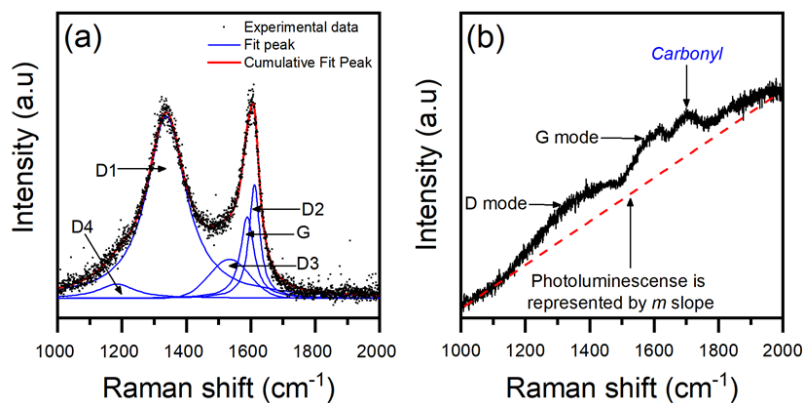

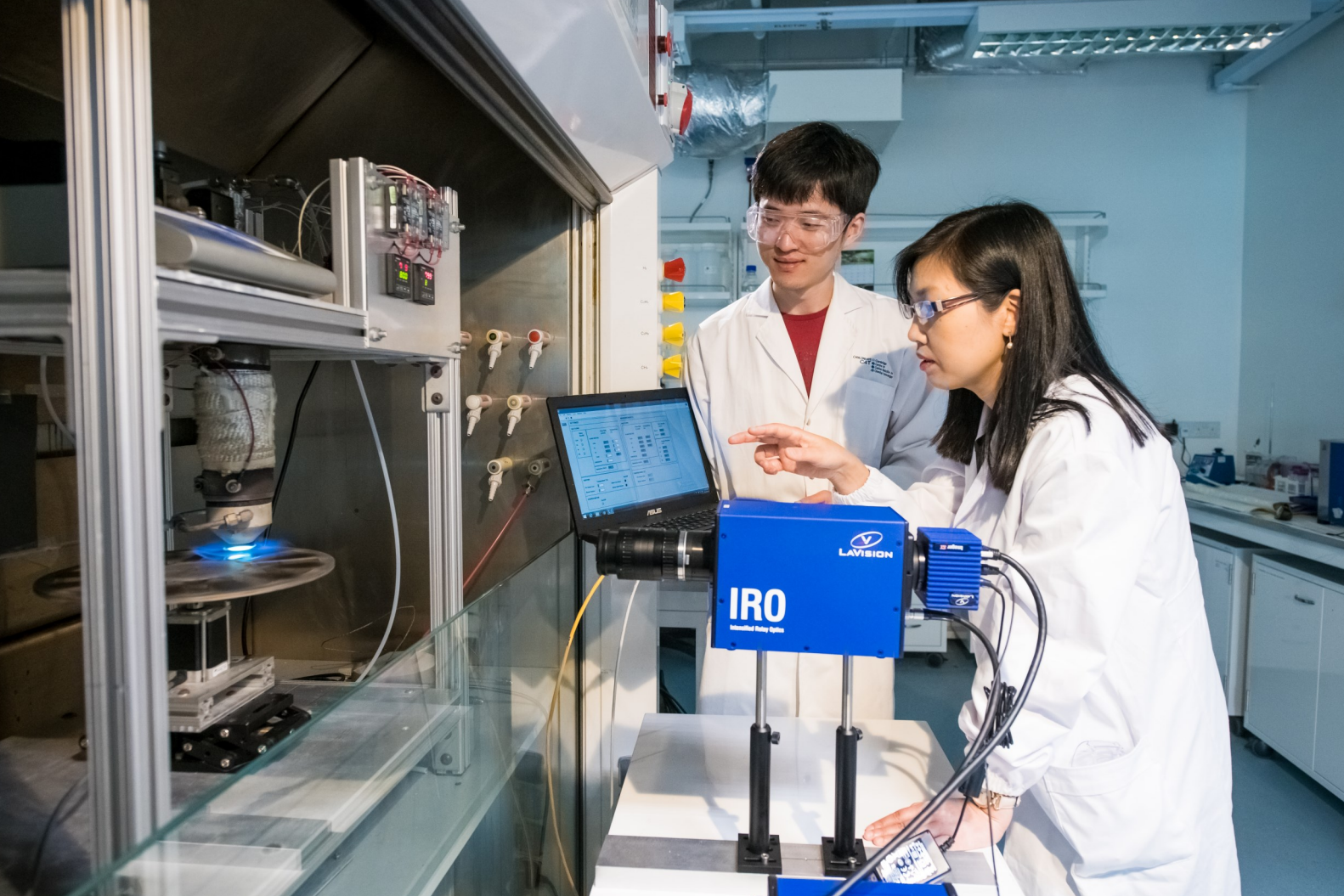

Fig. 3.12: FSRS flame stabilised on a rotating surface used to synthesise metal oxide nanoparticles.

Update on work package 3.3

Nanoparticle/film flame synthesis—kinetics and application

Over the last six months, Shuyang WU's (PhD student, NTU) research has mainly been focussed on premixed stagnation flame synthesised TiO₂ nanoparticles with mixed phases for efficient photocatalytic hydrogen generation. The goal and significance of this work are to seek a sustainable way to produce green energy to substitute traditional fossil fuels and further solve the global energy shortage and mitigate the greenhouse effect. The optimised anatase/rutile/srilankite TiO₂ sample we synthesised with as low as 0.1 wt% of Pt co-catalyst exhibits a remarkable photocatalytic H₂ generation rate of 21.9 mmol/g/h and an apparent quantum efficiency (AQE) of 39.4% at 360 nm, higher than those of anatase/rutile or anatase TiO₂. The less studied srilankite phase is for the first time investigated for photocatalytic H₂ generation. It is revealed that a relatively low content of srilankite phase in TiO₂ could efficiently promote charge separation and transportation. It is

remarkable that compared to the commercial P25 TiO₂, the flame-made TiO₂ significantly improves Pt reduction and dispersion owing to the oxygen vacancies and surface defects. The optimised TiO₂ sample with surface defects facilitates the deposition of ultra-small Pt nanoclusters of around 0.63 nm and stabilises the low valence state of Pt⁰, leading to efficient utilisation of noble metal and remarkable enhancement of the H₂ generation rate.

Astrid Boje (PhD student, CAM) has been working on modelling synthesis of particulate titanium dioxide (titania) using detailed population balance models. She has been developing methods to resolve the numerical issues that arise when using population balance modelling techniques to study particle synthesis under industrial conditions. These high concentration and temperature conditions are associated with rapid particle formation

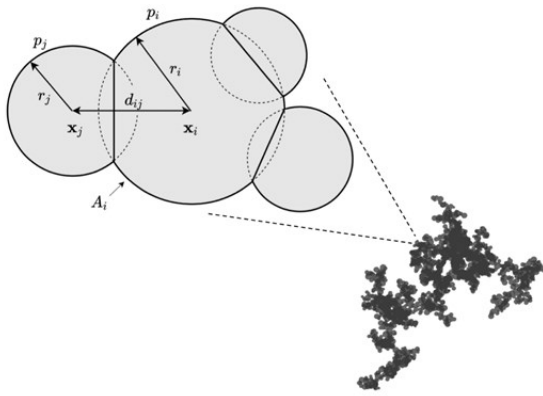

Fig. 3.13: Illustration of the detailed particle model type-space.

Casper Lindberg

and growth, which introduces computational challenges. Astrid has recently implemented a hybrid particle-number model and detailed particle model in our in-house population balance code (MOpS). In the new model, small particles are treated simply while large particles and aggregates are resolved with as much detail as possible. This facilitates economical solution of population balance equations under high rate conditions where inception of a high number density of small particles makes resolving less abundant, larger aggregates computationally challenging, especially when particle surface processes such as heterogeneous reaction are significant. She is currently working on a paper to present this work.

Casper Lindberg (PhD student, CAM) has developed a detailed population balance model for titanium dioxide to simulate the complex aggregate morphology of flame synthesised nanoparticles. This work is currently being prepared for submission. In collaboration with Manoel Manuputty (PhD student, CAM), Casper developed a two-step simulation methodology allowing the detailed population balance model to be applied to the modelling of stagnation flame synthesised nanoparticles, for example, titanium di-

oxide aggregates produced from titanium tetraisopropoxide (TTIP) precursor. This methodology facilitates simulation of quantities that are directly comparable to experimental observations; for example, primary particle size distributions and aggregate projected area distributions obtained from TEM images. The two-step methodology was the subject of a talk at the 6th International Conference on Population Balance Modelling in Ghent, Belgium and a paper has been submitted for review. Furthermore, the methodology and detailed model are currently being used to model experiments performed by Manoel in the CARES lab.

Manoel Manuputty's (PhD student, CAM) main research interest is the computational and experimental investigation of titania (TiO₂) nanoparticle formation in flame synthesis. Recently, he has been working on a detailed morphological characterisation of the synthesised nanoparticles using a transmission electron microscopy (TEM) image analysis and differential mobility spectrometer (DMS) measurements. The detailed morphological characterisation allows a direct comparison with the simulation results using a detailed stochastic particle model, in collaboration with Casper Lindberg (PhD student, CAM). This is required for the evaluation of the model parameters and improves our understanding of the complex processes involved in the nanoparticle formation in the gas phase. Further work includes modelling of the crystal phase formation and transformation of titania, which can be compared against recent experimental data.

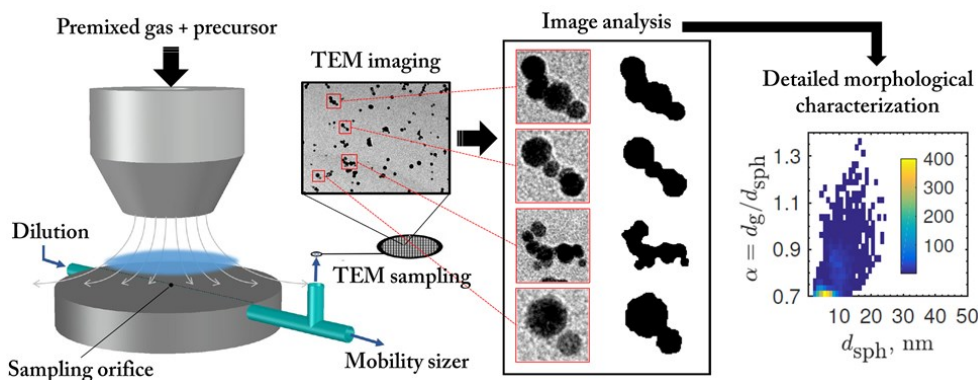

Fig. 3.14: Titania nanoparticle formation in flame synthesis.

Manoel Manuputty

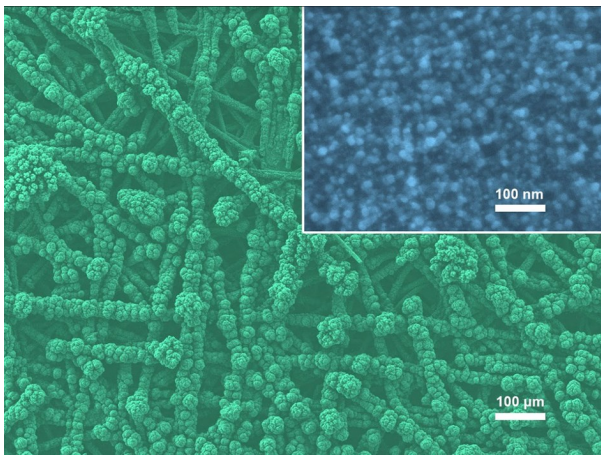

Fig 3.15: SEM images of carbon-protected Ni-Fe alloy nanoparticles deposited on carbon paper.

Dr SHENG Yuan

Dr SHENG Yuan (Research Fellow, NTU) has developed a series of novel water splitting electrocatalysts using flame synthesis. The more notable ones include carbon-protected ultrasmall (2-3 nm) cobalt-iron and nickel-iron alloy nanoparticles and nickel-iron phosphide/phosphate nanoparticles. In a premixed stagnation flame, the catalysts were continuously synthesised and deposited onto carbon paper to produce water oxidation electrodes ready for use. So far the best performing as-prepared electrode has exhibited an oxygen evolution overpotential of 280 mV and a Tafel slope of 29 mV/dec at the current density of 10 mA/cm². To expand the capability of the

synthesis burner, Dr Sheng has modified the current system to allow simultaneous delivery of multiple solid and liquid precursors to the flame. In principle the burner can now produce ternary metal oxides and more complex materials. An operando FTIR system has been set up by Dr Sheng to characterise the electrocatalysts in their working condition. To push the flame-synthesised catalysts toward practical applications, he has designed and built a liquid electrolysis cell consisting of gas diffusion electrodes for reduction of CO₂ at high current densities. He has also set up a photocatalytic reactor to explore potential flame-synthesised catalysts for CO₂ conversion using solar energy directly.

Update on work package 3.4

Modelling and optimisation of unit operations

Aravind Devanand (PhD student, NUS) has been implementing a modular nuclear power plant model in the J-Park Simulator. The model identifies the best-suited locations for placing modular nuclear power plants across Jurong Island. The selected locations will be capable of meeting the entire energy demand of Jurong Island with minimum cost and risk to the neighbourhood. The model is formulated as a multi objective Mixed Integer Non-Linear Programming (MINLP) problem in GAMS. The data required for the model is taken from the JPS knowledge base using a set of SPARQL queries. It is then executed using the Baron solver in GAMS and the results are updated in the knowledge base. The output from the model is visualised using Google maps API and it is made available on the JPS website. The entire process is automated using a series of agents and it can be executed from the JPS website.

Currently, Aravind is working on creating an ontology-based energy bidding market for an eco-industrial park (EIP). Any market primarily involves three entities which are the consumers, the producers and the mediator. In the case of an energy market the consumer will be the industries on the EIP and the producers will be power plants. The mediator can be any third party whose authority is recognised by both the producer and consumer. These entities are represented using a multi agent system that tries to increase the collective profit of the EIP rather than focusing on the profits of individual entities. The model utilises Semantic Web Rule Language (SWRL) based rule framework to ensure fair trading practices. This work is still in the developmental phase and is expected to be completed by November 2018.

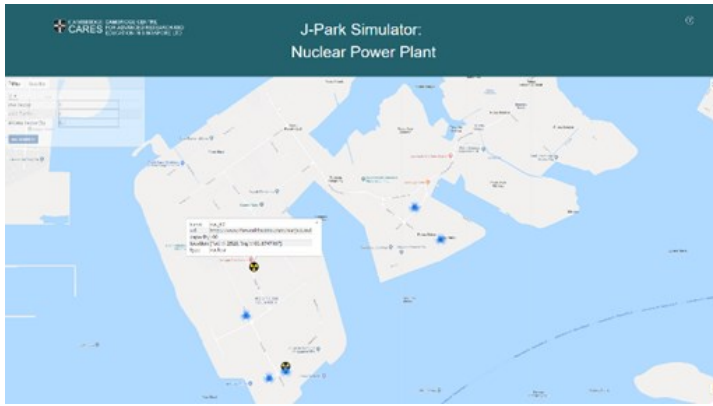

Fig 3.16: JPS website showing the potential locations of modular nuclear power plants.

Aravind Devanand

Pulkit Chhabra (PhD student, NUS) has recently submitted his thesis with the title “Modelling and Optimisation of Biodiesel Reactor and Feedstock”. His work looks at how the depletion of fossil fuel resources and increasing environmental concerns have influenced many countries to consider alternative fuels. One such alternative fuel is biodiesel, which has gained enormous impetus in the past two decades. Biodiesel is a non-toxic, biodegradable, and environmentally benign fuel that can be used in diesel engines. However, one of the major obstacles to the commercialisation of biodiesel is the cost of the feedstock, which accounts for approximately 60 to 80% of the total production cost. Hence, optimal selection of the feedstock plays a vital role. Two major factors are focussed on that significantly influence the role of feedstock in the production of biodiesel viz. composition and source (food or non-food crops) of the feedstock. The former is addressed by developing generalised kinetic models of varying complexity for biodiesel production. The models are based on the reaction scheme of different glycerides and esters that constitute the feedstock, thus ensuring its applicability to feedstocks of varying composition. For the latter, the generalised model is employed to study the effect of feedstocks (varying source) on the optimal operating conditions and the biodiesel properties. Moreover, recommendations are provided for optimal feedstock composition

to produce premium quality biodiesel, i.e. one that meets the standard specifications. Finally, the effect of uncertainty is incorporated in the optimisation to quantify its effect on the optimal feedstock characteristics and the reactor’s operating conditions. Overall, the aim of the work is to contribute towards finding the best quality feedstock, thereby reducing the overall production cost and facilitating the acceptance of biodiesel by both customers and vehicle manufacturers.

VO Chi Hung’s (Clifford) (PhD student, NUS) main research interest lies in the biological fixation of CO₂ using the archaeon *M. maripaludis* S2. Unlike many other microbes which require organic feedstock, this microorganism can convert CO₂ into CH₄ without any organic carbon input. For the past six months, Chi Hung has successfully cultivated this archaeon in a minimal medium (only consisting of inorganic salts). Currently, he is studying the products secreted by this microorganism in the liquid phase. He has found that this archaeon can produce lactate, formate, acetate and formaldehyde. A kinetic study is underway.

Fig 3.17: Cultivation of *M. maripaludis* S2 in a minimal medium.

VO Chi Hung

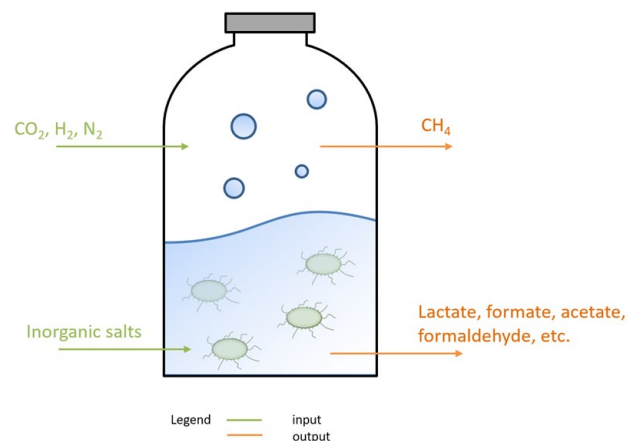

Update on work package 3.5

Automated model development and experimental design/decision support

Khamila Nurul Khaqqi (PhD student, NTU) has been working on examining the performance adaptability of the trading mechanism introduced in the blockchain-enabled reputation-based emission trading scheme that she proposed previously. She found a consistent result across different price levels and market depth. As the application of blockchain technology changes the architecture of the market, she also observed a few characteristics of the resulted market. Three characteristics

that she observed are the market price, market liquidity and selectivity. The result is interpreted for its implication in achieving the design objective of the proposed system. That objective is to create an information asymmetry that will increase the price of the emission permit for companies that are resistant to emission reduction efforts. A paper on this research has been submitted to the journal *Applied Energy*.

Scientific output

The following are some examples of CREATE-acknowledgement papers generated by IRP3 during the reporting period. A full list of publications may be found on page 87.

Internal structure of soot particles in a diffusion flame

Maria Botero, Yuan Sheng, Jethro Akroyd, Jacob Martin, Jochen Dreyer, Wenming Yang and Markus Kraft

DOI: 10.1016/j.carbon.2018.09.063

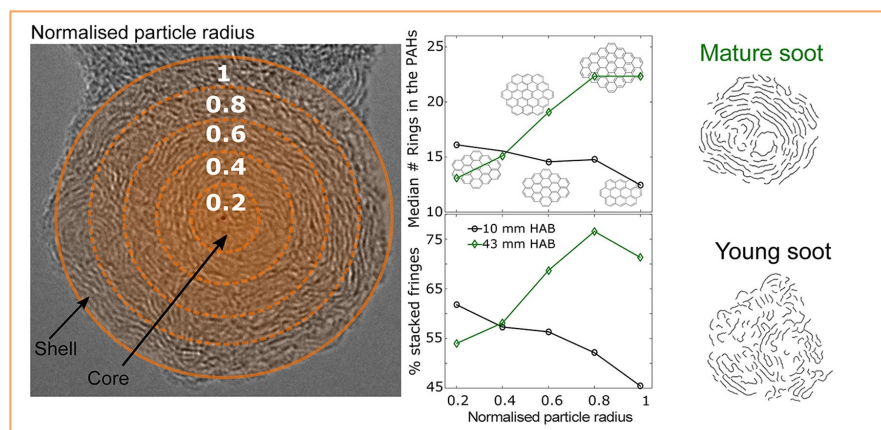

Abstract: The evolution of the internal structure of soot particles was studied in a coflow diffusion flame. Soot particles from the flame were imaged using high resolution transmission electron microscopy. An algorithm to quantify the nano-structure of the particles was extended to study the radial distribution of fringes within the particles. The approximate size of the molecules in the particles was calculated from the fringe lengths, assuming planar peri-condensed PAHs. The molecules are slightly larger (~16 rings) and more stacked at the core than at the surface (~12 rings) of the youngest particles sampled, suggesting that the particles could be formed via the stabilisation of a nuclei of larger PAHs and condensa-

tion of smaller PAHs on their surface. In the lower-temperature region of the flame the molecules grow mainly at the surface of the particles, whereas the molecules in the core of the particles become less stacked and slightly smaller, indicating some degree of nano-structural mobility. In the higher-temperature region of the flame, a graphitisation process takes place, with the development of a shell of longer (~20 rings), flatter and more compact molecules, and an immobilised amorphous core. At the tip of the flame the particles are oxidised, mainly through surface oxidation.

An ontology framework towards decentralized information management for eco-industrial parks

Li Zhou, Chuan Zhang, Iftekar Karimi and Markus Kraft

DOI: 10.1016/j.compchemeng.2018.07.010

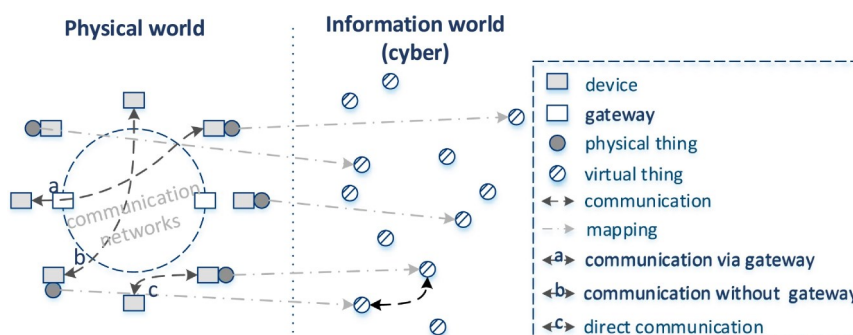

Abstract: In this paper, we develop a skeletal ontology for eco-industrial parks. A top-down conceptual framework including five operating levels (unit operations, processes, plants, industrial resource networks and eco-industrial parks) is employed to guide the design of the ontology structure. The detailed ontological representation of each level is realised through adapting and extending OntoCAPE, an ontology of the chemical engineering domain. Based on the proposed

ontology, a framework for distributed information management is proposed for eco-industrial parks. As an example, this ontology is used to create a knowledge base for Jurong Island, an industrial park in Singapore. Its potential uses in supporting process modeling and optimisation and facilitating industrial symbiosis are also discussed in the paper.

Sooting characteristics of polyoxymethylene dimethyl ether blends with diesel in a diffusion flame

Yong Ren Tan, Maria Botero, Yuan Sheng, Jochen Dreyer, Rong Xu, Wenming Yang and Markus Kraft

DOI: 10.1016/j.fuel.2018.03.051

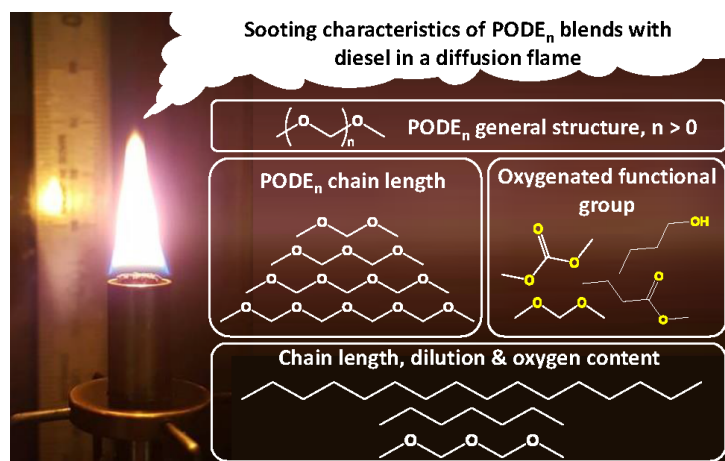

Abstract: The evolution of the internal structure of soot particles was studied in a coflow diffusion flame. Soot particles from the flame were imaged using high resolution transmission electron microscopy. An algorithm to quantify the nanostructure of the particles was extended to study the radial distribution of fringes within the particles. The approximate size of the molecules in the particles was calculated from the fringe lengths, assuming planar peri-condensed PAHs. The molecules are slightly larger (~16 rings) and more stacked at the core than at the surface (~12 rings) of the youngest particles sampled, suggesting that the particles could be formed via the stabili-

sation of a nuclei of larger PAHs and condensation of smaller PAHs on their surface. In the lower-temperature region of the flame the molecules grow mainly at the surface of the particles, whereas the molecules in the core of the particles become less stacked and slightly smaller, indicating some degree of nano-structural mobility. In the higher-temperature region of the flame, a graphitisation process takes place, with the development of a shell of longer (~20 rings), flatter and more compact molecules, and an immobilised amorphous core. At the tip of the flame the particles are oxidised, mainly through surface oxidation.

Other activities and achievements

Dr LIM Mei Qi (Project Manager, CARES) prepared, coordinated and presented the J-Park Simulator to the Executive Director of the Institute of Chemical & Engineering Sciences, the Chief Executive of Singapore Energy Market Authority, the Head and Director of the Innovation Program Office of Surbana Jurong, the President of the University of Zurich, and the Vice-Chancellor of the University of Cambridge.

Jacob Martin's (PhD student, CAM) work on the nanostructure of soot was published on the Phys.org website:

<https://phys.org/news/2018-09-soot-forensics-carbon-fingerprints-reveal.html>

Prof. Markus Kraft (PI, CAM) along with many members of IRP3 attended the 37th International Symposium on Combustion in Dublin, Ireland from 29 July – 3 August (image below).



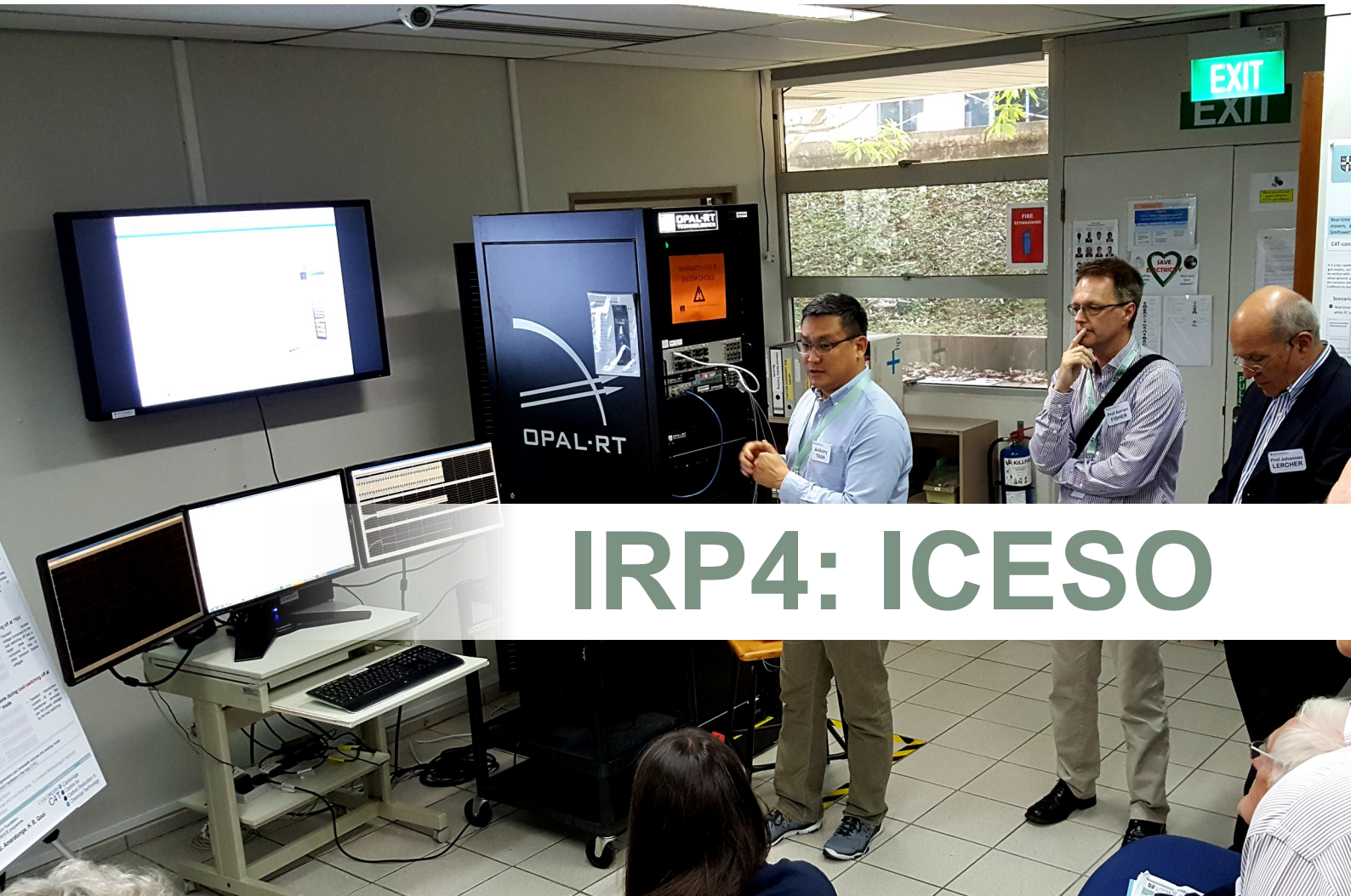

IRP4: ICESO

INTEGRATED CHEMICALS AND ELECTRICAL SYSTEMS OPERATION

ICESO focuses on the Jurong Island electrical sub-network to optimise coordination of energy generation and consumption within the electrical/chemical system. ICESO seeks to discover how a tighter integration of electrical supply network and chemical supply plant load can reduce the carbon footprint of the chemical industry, given the trend towards smart grids.

ICESO is led by PIs:

Prof. Gehan Amaratunga (CAM)

Prof. Jan Maciejowski (CAM)

Prof. Keck-Voon Ling (NTU)

Prof. Sanjib Kumar Panda (NUS)



OVERVIEW

ICESO aims to exploit synergies in the generation and consumption of electrical and thermal energy, in the context of industrial consumers, especially in the chemical industries, in order to reduce the amount of energy that needs to be generated and hence to reduce the associated carbon emissions. The expertise in the ICESO team is concentrated in control systems and in electrical power distribution. Research Fellows were recruited with expertise in multi-agent power system control, artificial intelligence methods for smart grid configuration, communication strategies for power system data acquisition and for real time control, model predictive control, in non-convex optimisation, and in power network analysis. Resources available to IRP4 include two lab-scale microgrids (one at NTU and one at NUS), which include real and simulated renewable and traditional generators. We also acquired a powerful real-time power system simulator.

IRP4 has addressed questions related to the coordination of electrical and thermal power generation, distribution and consumption. The possibility and impact of introducing renewable generation, in addition to traditional generators, have been investigated. The heterogeneous structure of the power system, including the incorporation of microgrids as subsystems, was also studied. This is particularly suitable for including the chemical plant electrical network and its loads, together with any co-generation sources, as an extension of the distribution system. With IRP3, directly linking the electrical loads (e.g. pumps, motors) to chemical process parameters in a simulation envi-

ronment was explored, and this work will be continued in Phase 2, in IRP JPS. The impact of such loads on the larger network, for example in terms of power factor and harmonic generation, is a key consideration in terms of modelling. Various problems were addressed, both standard power system problems and new ones which arise as a result of these various possibilities. One major question which was identified is: Is it appropriate to maintain the traditional time-scale hierarchy for controlling power systems, when the range of time constants of equipment is being reduced, and computational algorithms are getting more powerful? A range of problems was considered, from automatic voltage control to optimal dispatch problems, with both centralised and decentralised control structures being investigated.

The research vision was to work towards a new architecture of control, estimation and optimisation for a 'smart future grid' that facilitates the optimal dynamic operation of power systems at intervals of a few minutes. This dynamic operation contrasts with the usual 'quasi-static' operational regime of the currently operated power systems that look for an update at every half an hour or a longer time interval. While no definitive answers to these various questions were obtained, useful contributions have been made to the planning and operation of future power distribution systems, at both short and long time scales, including both technical and economic considerations.

Prof. Gehan Amaratunga, PI

Prof. Jan Maciekowski, PI

University of Cambridge

Update on work package 4.1

Fast numerical algorithms for solving large MPC problems for networked systems

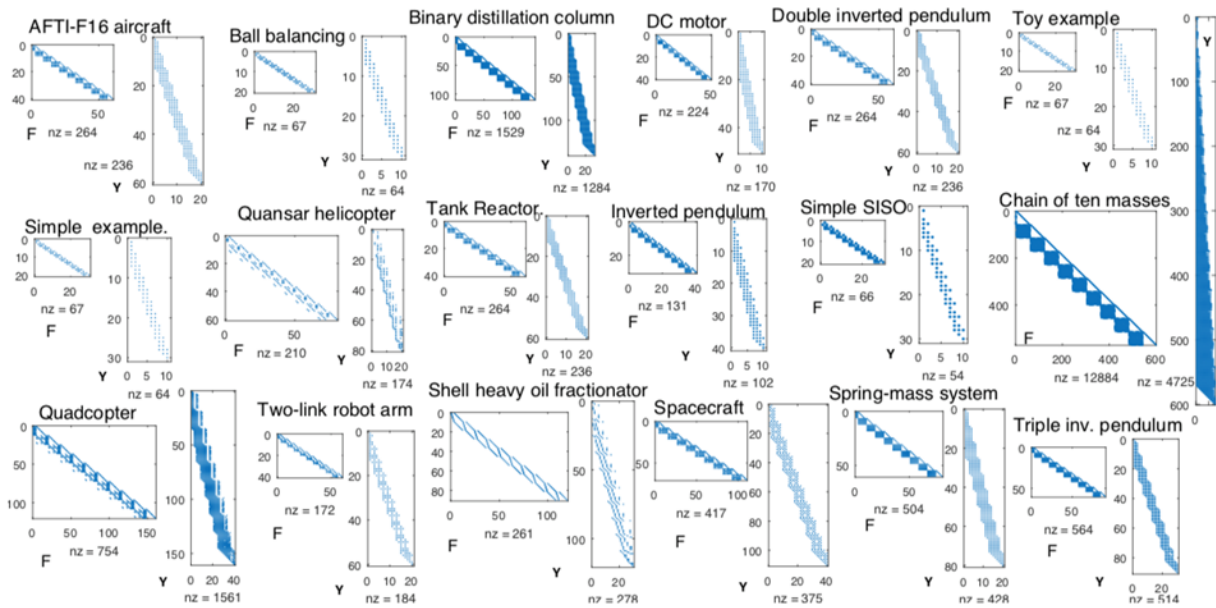

Fig 4.1: Banded null basis in 18 Model Predictive Control problems.

Thuy V. Dang

Thuy V. Dang (PhD student, NTU) worked on banded null basis method for accelerating the computation of Model Predictive Control. This work will soon be submitted to a journal. In addition,

his work on anytime control algorithms for networked/embedded systems has been published in IEEE Transactions on Automatic Control.

Update on work package 4.2

Extension of multiplexed MPC to non-Gaussian noise, nonlinear and hybrid models

Dr Bhagyesh Patil (Research Fellow, NTU) has completed work on the solution of global optimisation of non-convex problems that arise in electric power networks. This has been mainly applied to the “AC Optimal Power Flow” problem, in which the optimal routing of power from generators to consumers is determined, in particular in critical heavily-loaded conditions when linearising assumptions on transmission lines do not

hold. A novel algorithm has been proposed which combines sequential linear programming with the use of trust regions. Previous work on Bernstein polynomials for global optimisation has been extended to deal with “hybrid” systems, in which discrete as well as continuous variables appear (for example, disconnecting generators or consumers).

Update on work package 4.3

Modelling and control of heterogeneous power generation networks with chemical process loads

QIU Xueheng (PhD student, NTU) reports that better time series forecasting models have been investigated and proposed by developing better ensemble strategies. Specially, short-term electric load forecasting plays an important role in the management of modern power systems. Improving the accuracy and efficiency of electric load forecasting can help power utilities design reasonable operational planning, which will lead to the improvement of economic and social benefits of the systems. A hybrid incremental learning approach composed of Discrete Wavelet Transform (DWT), Empirical Mode Decomposition (EMD) and Random Vector Functional Link network (RVFL) is presented in this work. RVFL network is a universal approximator with good efficiency because of the randomly generated weights between input and hidden layers and the close form solution for parameter computation. By introducing incremental learning, along with ensemble approach via DWT and EMD into RVFL network, the forecasting performance can be significantly improved with respect to both efficiency and accuracy. The electric load datasets from Australian Energy Market Operator (AEMO) were used to evaluate the effectiveness of the proposed incremental DWT-EMD based RVFL network. Moreover, the attractiveness of the proposed method can be demonstrated by the comparison with eight benchmark forecasting methods.

The topic of Xueheng's project is "Ensemble Time Series Forecasting Algorithms with Applications in Power Systems and Financial Markets". Currently, his research field is mainly focused on deep learning methods and ensemble algorithms. In Xueheng's study, various kinds of time series forecasting algorithms have been reviewed, in-

cluding Artificial Neural Network (ANN), Support Vector Regression (SVR), Random Forest (RF), Kernel Ridge Regression (KRR), Deep Belief Network (DBN), Long Short Term Memory (LSTM) and ensemble methods. A decision tree ensemble method called least square estimation based oblique RF has been proposed for time series forecasting, which has been recently published in the journal *Information Sciences*.

Xueheng has also investigated a randomised version of neural network, which is called Random Vector Functional Link Network (RVFL), and proposed an effective and efficient learning model for short term electricity load demand forecasting by combining Discrete wavelet transform (DWT), EMD and RVFL with incremental learning. This work has been accepted by the journal *Knowledge-Based Systems*. Moreover, an Empirical Mode Decomposition based incremental ensemble approach is proposed for crude oil price forecasting, which has been accepted by the SSCI2018 conference. For future research directions, multivariate time series forecasting models shall be constructed, using the potential learning ability of deep learning methods. Moreover, the concept of deep learning can also be applied with RVFL to develop deep RVFL structure to make use of RVFL's advantages for computation time.

Rémy Rigo-Mariani (Research Fellow, NTU) has worked on the design, planning and operation of power distribution systems, taking into account CO₂ emissions as well as monetary costs. This has built on his earlier work on modelling CO₂ emissions from combined-cycle power plant. The technical challenge here is the very many possible configurations which must be considered, and which lead to overwhelming computational complexity if tackled naively.

Update on work package 4.4

Modelling of chemical process loads and local generator-based electrical network akin to Jurong Island

Srinivasa Rao Kamala (PhD student, NUS) is studying the small-signal stability analysis of micro-grids when subjected to small or large disturbances. Micro-grid small-signal stability is affected by many factors, including initial operating conditions, types of sources in the system, characteristics of various loads (e.g. constant power loads). In this report, a method for d - q frame impedance measurement and the small signal stability analysis of a three-phase power electronic converter-based system with constant power loads (CPLs) is presented. In this method, a multi-tone current signal is generated based on the Newman's optimal phase angle to measure d - q frame impedances and subsequently the system stability is analysed using general Nyquist Stability Crite-

ria based on the source and load impedances. After analysing stability, an active control method is applied to improve the stability margin of the system based on the grid impedance conditions by reshaping the impedance profile of the load subsystem containing the CPL. The effectiveness of active control method has been tested in MATLAB/Simulink simulation environment for a three-phase motor drive system feeding through an active front end (AFE) rectifier, which behaves as the CPL. Figure 4.2a and Figure 4.2b show the test system and its d - q domain equivalent circuit. A general multi-sine injection signal, Newman's optimal injection signal and its FFT plot are shown in Figure 4.3a and the impedance measurement algorithm is shown in Figure 4.3b.

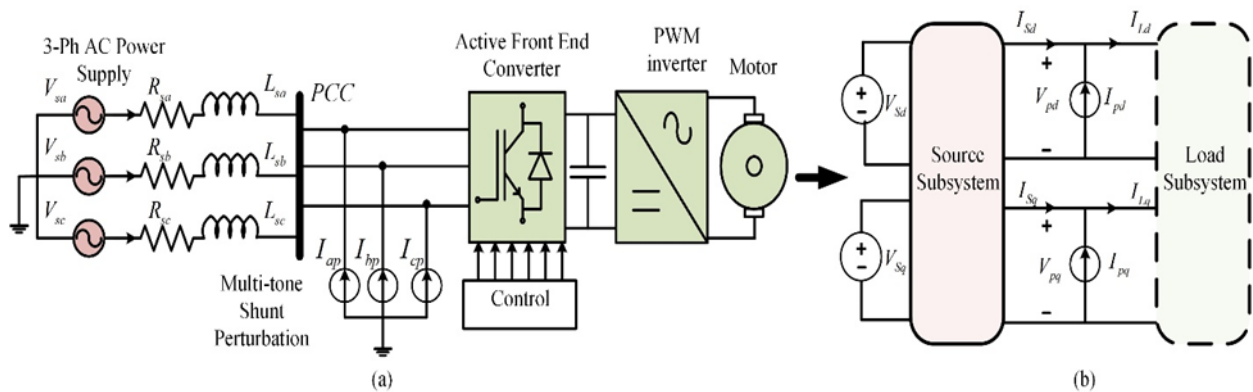

Fig 4.2: (a) The 3-phase motor drive system with AFE and (b) d - q frame representation with shunt perturbation.

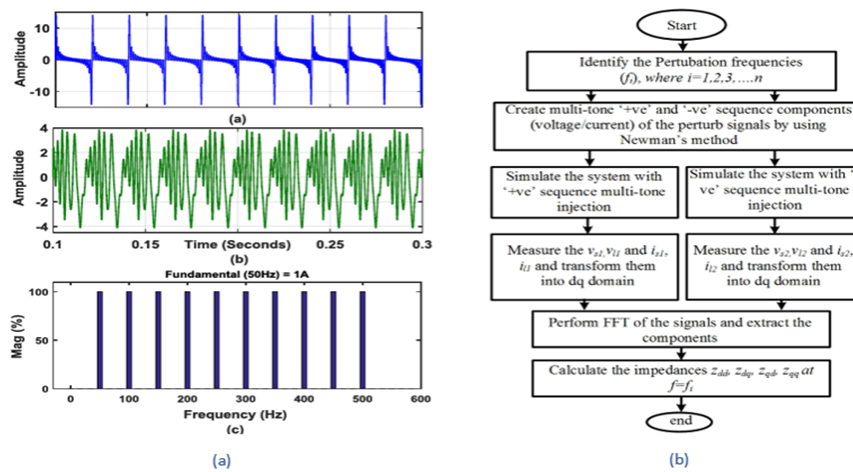

Fig 4.3: (a) General multi-tone signal, multi-tone signal generated by Newman's method and its FFT plot. (b) Impedance measurement algorithm.

Srinivasa Rao Kamala

The stability analysis using the Nyquist stability criterion for return ratio term i.e. d -axis term of the return ratio L_{dd} and the Nyquist plot is shown in Figure 3(b). From the Figure 3(b), it can be concluded that the system is stable, and the phase margin (PM) is 70° (see blue line). Once the stability of the system is analysed, it's possible to reshape the source/load

sub-subsystem impedance plots to improve the system stability margin by means of the internal control algorithm. In the present work, to improve the stability margin, only the bandwidth of the voltage controller of the AFE is varied to reshape the impedance profile of the load, because the grid impedance cannot be changed. Bandwidth of the voltage controller has influence on the converter output impedances i.e. the lower the voltage loop bandwidth is, the higher the output impedance. Figure 4.4a and Figure 4.4b give the simulation result for the test system with different voltage controller i.e. controller with higher bandwidth (green line). It is clear from the Figure 4.4b that, the input impedance of the CPL is increased to improve stability margin and it's improved from 70° to 81° .

Partha Pratim Biswas (PhD student, NTU) is now a Senior Research Engineer researching the planning of power transmission and distribution networks, the power flow in the network, distributed generations, integration of renewable sources in

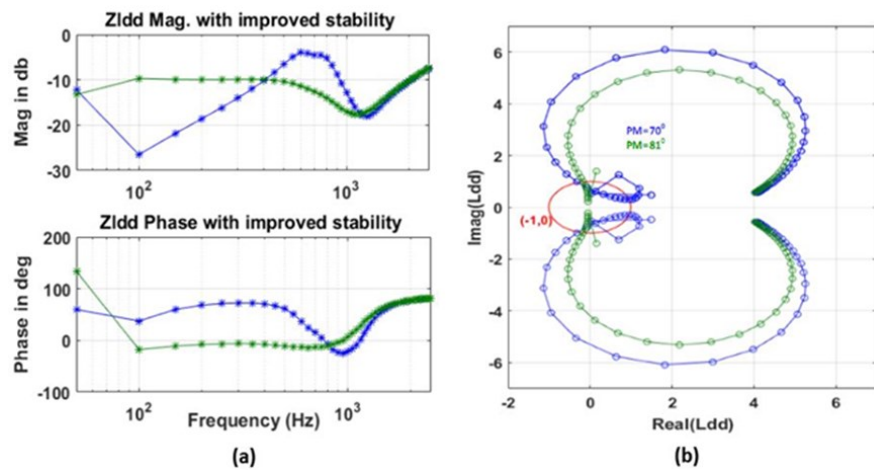

Fig 4.4: (a) Impedance plot for L_{dd} term for weak grid scenario (blue line) and improvised L_{dd} (green line) after applying the stability improvement method. (b) The GNC plot for the L_{dd} term.

Srinivasa Rao Kamala

smart grids and design of power quality improvement filters. Maximising profit and minimising cost, system losses and carbon emissions are usually set as the objectives of the optimisation problems. As most of these optimisation problems are non-linear and constrained, classical methods are not very effective in solving them. In last couple of decades, population-based metaheuristics have gained immense popularity due to their strengths in solving non-linear, multimodal and constrained optimisation problems. The research works in Partha's PhD thesis emphasise primarily the performance evaluation of these metaheuristics, also called evolutionary algorithms, for single-objective and multi-objective optimisation problems in power systems.

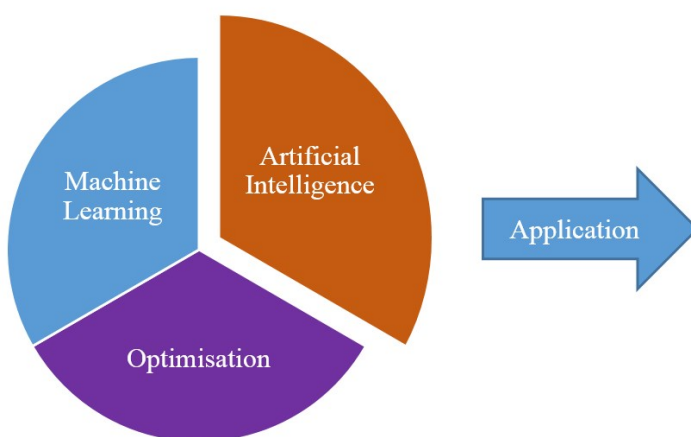

Fig. 4.5: An overview of Partha's current research.

Partha Pratim Biswas

Dr Joymala Moirangthem (Research Fellow, NUS): One of the most challenging tasks in an electrical power system for its operators is maintaining the system’s electrical security. System assessment tasks such as monitoring and contingency analysis are very important to make the power system secure and reliable. Contingency analysis is one of the techniques widely used to predict the effect of outages like failure of equipment, transmission line failure etc. on the power system. This allows the system operators to take necessary actions (preventive and corrective operation) in order to prevent blackout events. Power-flow analysis is the backbone to perform the contingency studies. For a complex electrical grid (the grid moving towards modernisation), computing the power-flows and bus voltages using the traditional power flow method consumes a lot of time and also doesn’t guarantee the solutions. Increase in the number of components, allowing system to operate closer to their capacity, and integrating intermittent renewable energy sources have increased the probability of multiple component failures. A fast power-flow algorithm could be used to perform an (N-1) or (N-x) contingency analyses. A holomorphic embedded power flow (HEPF) method has been extended to study the effect on an electrical grid due to (N-1) contingency. The above method has been tested on WSCC (Western Sys-

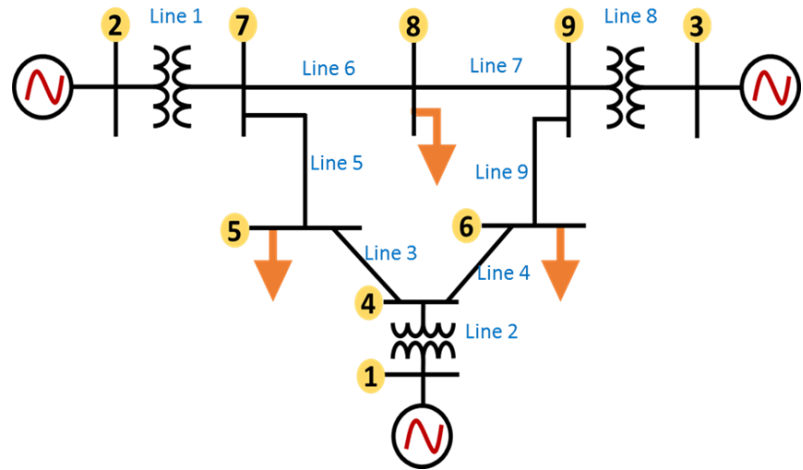

Fig 4.6: Single line diagram of WSCC system.

Dr Joymala Moirangthem

tem Coordinating Council) system, which is the IEEE 9-bus system as shown in Figure 4.6, thus creating transmission line outage one at the time. The contingency ranking has been done based on the severity of the system. The severity is determined by calculating the total sum of voltage performance index (PIV) and real-power performance index (PIP). The highest value indicates higher rank and higher level of severity. Figure 4.7 and Figure 4.8 show the graphical representations of these performance indices for each outage cases, and contingency ranking for this bus system based on the PIP and PIV values is shown in Figure 4.9. It is clear from Figure 4.9 that the contingency number 3 which the line outage corresponding to the line connected between buses (5-4) is the most severe contingency.

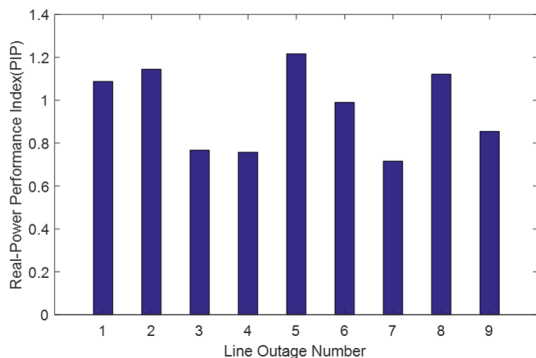

Fig 4.7: Values of real-power performance index (PIP) for IEEE 9-bus system.

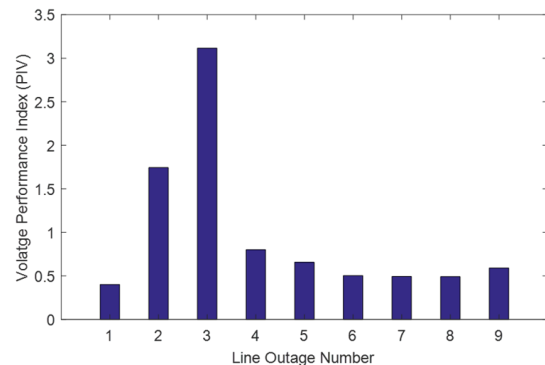

Fig 4.8: Values of voltage performance index (PIV) for IEEE 9-bus system.

Dr Joymala Moirangthem

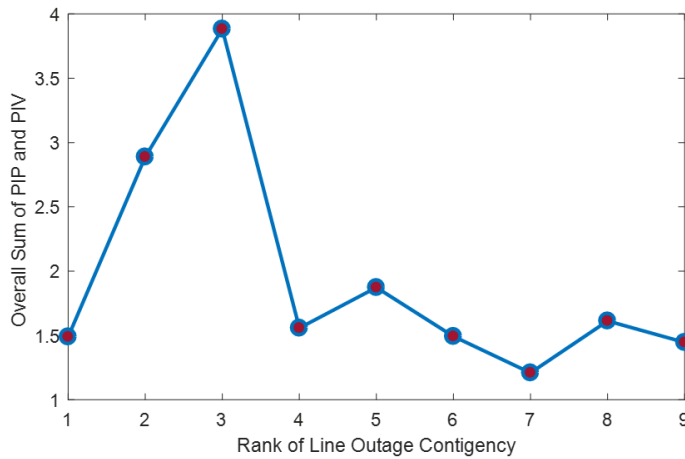

Fig 4.9: Contingency ranking based on the overall sum of PIP and PIV of IEEE 9-bus system.

Dr Joymala Moirangthem

cations, she had been working on unit commitment problem and optimal power flow problem from power system operation and planning.

The unit commitment problem (UCP) in power systems is an important optimisation problem

Dr Bhagyesh Vijay Patil (Research Fellow, NTU) reports on the development of the decentralised nonlinear MPC scheme for excitation of multimachine power systems. Modern electrical power systems have experienced great changes due to large complexities arising from increasing levels of inter-connections and the introduction of new technologies such as FACTS, HVDC, renewable energy sources etc. In addition, in modern power systems, the distances between the places where energy is generated and consumed are often large. As a consequence the transients occurring among energy generating units might result in blackouts. In this environment safe, stable, and efficient operation of power systems under transients has become quite challenging. This work investigates a novel decentralised solution approach based on the MPC philosophy for efficient operation of the power system.

which schedules the generating units while satisfying system and unit constraints with minimum production cost. For the unit commitment problem, Dr Lynn has been working with Rammohan Mallipeddi, who is an associate professor from Kyungpook National University, South Korea. They worked together on developing a new hybrid method comprising of priority list (PL) and particle swarm optimisation (PSO) to tackle the UCP. While Rammohan worked on the priority list method, Dr Lynn worked on the PSO and applied a new hybrid model to UCP. The performance of their proposed hybrid model called TPL_HCLPSO was evaluated using 10-, 20-, 40-, 60-, 80-, 100-bus benchmark power systems and compared with recent approaches such as deterministic, stochastic and the hybrid models. As shown in Figures 1 and 2, their proposed hybrid model achieved a remarkable cost reduction in power production and provided the lowest minimum production cost. The work has been completed and submitted to *Neural Computing Journal*.

Dr Nandar Lynn (Research Fellow, NTU) has been working on computational intelligent algorithms (particle swarm optimisation, differential evolution, etc.) and its applications. As the appli-

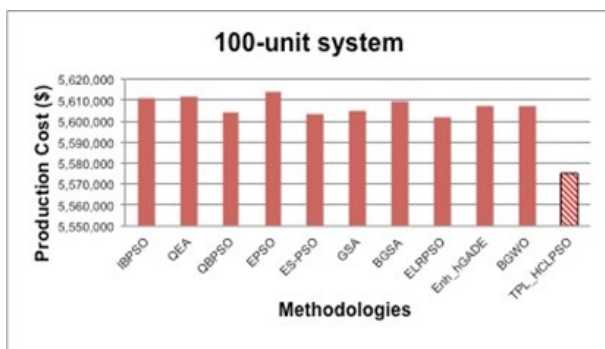

Fig 4.10: Production cost comparison.

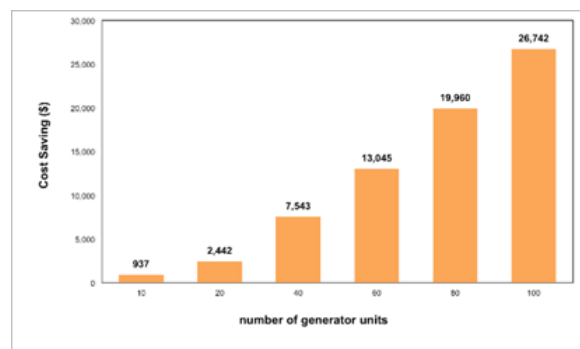

Fig 4.11: Cost savings of TPL_HCLPSO over other hybrid models.

Dr Nandar Lynn

The optimal power flow (OPF) problem determines the optimal settings of control variables at which the power system operates in the most secure, stable and reliable condition while satisfying all the physical and operational constraints. For the optimal power flow problem, Dr Lynn had been working with Partha, who is doing his PhD under Prof. P.N. Sugathan. They had been working on new OPF problem formulation with renewable energies as well as FACTS devices. FACTS stands for “Flexible AC Transmission System” and they are able to support voltage control, active and reactive power flow, transient stability and dynamic stability, etc. thereby enhancing the flexibility, stability, reliability and power transfer capability of the power system. Their new OPF problem determines the optimal operating level as well as the optimal setting of FACTS devices in a power system with wind and solar renewable resources. While Partha worked on modelling of FACTS devices, Dr Lynn implemented CI algorithms to new OPF problem and conducted the experiments on IEEE 30 and 57 bus benchmark

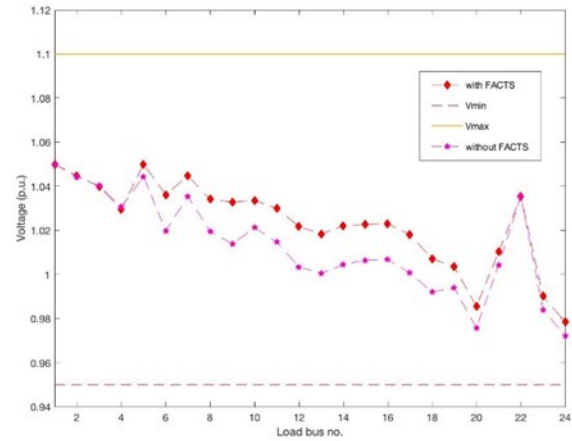

Fig 4.12: Voltage profile of IEEE 30 load buses.

Dr Nandar Lynn

systems. With FACTS devices, the active and reactive power losses as well as emission has been reduced as shown in Table 1. Also in Figure 4.12, it can be seen that the load bus voltage profile becomes improved and the voltage stability is enhanced. Dr Lynn has done all the simulations and is currently preparing a paper based on this work.

Table 1: Comparison with/without FACTS devices on OPF problem with renewable resources.

	Without FACTS	With FACTS
Emission (ton/h)	1.76222	0.16026
Active Power Loss (MW)	5.80970	5.71930
Reactive Power Loss (MW)	9.45780	7.43980
Voltage Stability (L-index (max))	0.14770	0.14610

Update on work package 4.5

Model building, integration and maintenance

Prof. Jan Maciejowski (PI, CAM) has continued work on fundamental input-output properties of linear dynamical systems. The work on the relationship between ‘inverse response’ of linear sys-

tems and the zero locations of transfer functions (already reported in previous reports) was presented at the 2018 European Control Conference.

Update on work package 4.6

Demonstration of proposed algorithms on pilot scale

Aparna Vijaya Mohan (Masters student, NTU) is working on the project “Grid connected and standalone operation of hybrid energy storage systems using three level dc-dc converters”. In this project, the new three-level bidirectional DC-DC converter configuration for the battery and

supercapacitor (SC) energy storage systems in DC microgrids will be investigated. The PI-based control method will be implemented to operate the proposed converter with the hybrid energy storage system. Furthermore, the DC microgrid with a three-level DC-DC converter will be con-

nected to the AC grid with a DC-AC converter. The grid-connected and islanding operating mode of the system will also be studied. The system operating principle, controller design, stability analysis, simulation and experimental studies will be analysed. The proposed three-level bidirectional DC-DC converter and DC-AC converter configuration can effectively integrate the battery,

SC and the AC grid with the bidirectional power flow. The proposed system and control algorithm will be simulated on Matlab/Simulink. She has completed the literature review of the project and yet to start with the simulation. The image shows the hardware setup of the project that is already available in the lab. The DC link needs to be extended and connected to the AC grid.

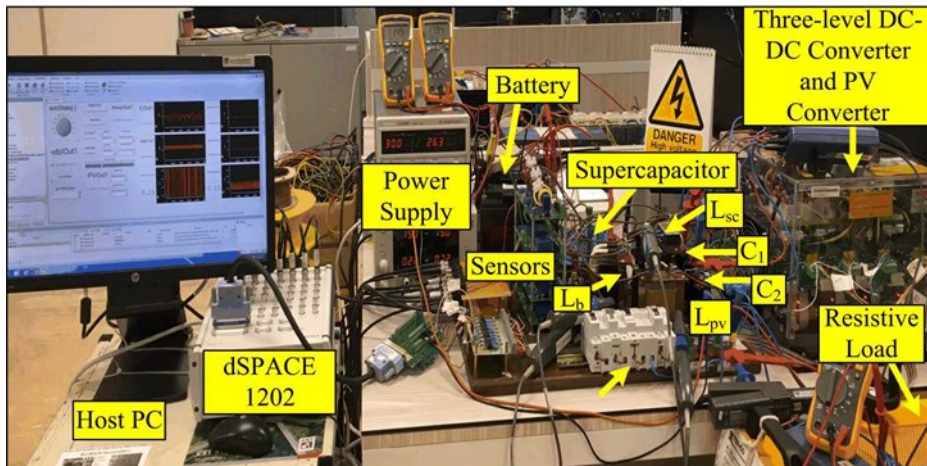

Fig 4.13: Hardware setup of Aparna's project "Grid connected and standalone operation of hybrid energy storage systems using three level dc-dc converters".

Aparna Vijay Mohan

Ashok Krishnan (PhD student, NTU) has been working on the optimal scheduling of multi-energy systems for industrial parks such as Jurong Island. Industrial parks such as Jurong Island are often huge consumers of electricity and thermal power. Additionally, they also host numerous combined heat and power plants (CHPs) which can be used to connect the electrical and thermal energy streams. Ashok's recent work looks at how the CHPs can coordinate with heterogeneous energy generation sources such as renewable energy sources, boilers, conventional fossil fuel-based generators, utility power, battery energy storage systems and thermal energy storage systems apart from flexible components such as interruptible and schedulable loads to ensure that the energy demand is satisfied in an optimal manner. Specifically, he looks at the participation of such multi-energy systems in the day-ahead electricity market by formulating and solving an optimal scheduling problem. An interesting feature of his work is the inclusion of electrical power flow constraints in the scheduling problem formulation to ensure the feasibility of the results obtained from an electrical network perspective.

He still hopes to collaborate with IRP3 researchers in Phase 2 to further expand the scope of his work by incorporating thermal network constraints in his optimal scheduling model to truly quantify the gains made in the energy system. For this, he hopes to leverage on some work already done in IRP3 on the design of park-level waste heat recovery systems.

Dr Eddy Foo (Co-PI, NTU) reports that the three-phase 45kVA power amplifier arrived in the microgrid testbed located at the Clean Energy Research Laboratory in NTU in September 2018. The power amplifier acts as an interface between the OPAL-RT real time digital simulator and the physical microgrid testbed. Power hardware in the loop (PHIL) experiments can be conducted with the power amplifiers which is an extension of the HIL experiments that have been done previously. The training and commissioning of the power amplifiers have been conducted in September. About seven participants attended the training.



Fig 4.14: The three-phase 45kVA power amplifier that acts as an interface between OPAL-RT and the physical microgrid testbed in Clean Energy Research Laboratory in NTU.



Fig 4.15: The power amplifier training session.

Dr Eddy Foo

After the installation of the three-phase 45kVA is complete, Prof GOOI Hoay Beng's (Co-PI, NTU) team plan to collect some Power-Hardware-in-the Loop (PHIL) results by interfacing the three-phase 45kVA power amplifier with OPAL-RT. Mr Ujjal Manandhar, a PhD student under Prof Gooi, will be tasked to conduct the above PHIL testing and collect the test results. He has also been working on a paper for presentation to Professor Amaratunga in the second half of October 2018.

On 1 August 2018 Prof Gooi presented Dr Prakash's paper, "Wavelet Transform-Spectral Kurtosis Based Hybrid Technique for Disturbance Detection in a Microgrid" at 2018 IEEE Power & Energy Society General Meeting, Portland, Ore-

gon, USA. In September, Ms Vijaya Mohan Aparna, an MSc student, was approved by CARES as a part-time student intern under the CARES project. She worked until Phase 1 of CARES C4T came to an end, on both the software and software aspects of the project, "Grid Connected and Standalone Operation of Hybrid Energy Storage Systems Using Three Level DC-DC Converters". She also assisted Ujjal. In September, the proposal entitled "A Universal Hardware-In-Loop Platform for Hybrid AC/DC Microgrids" was recommended to Office of Naval Research (ONR), US Navy. The proposal is now awaiting the final decision of ONR Acquisition Placement Office.

Scientific output

The following are some examples of CREATE-acknowledgement papers generated by IRP4 during the reporting period. A full list of publications may be found on page 87.

A robust power system stabilizer for enhancement of stability in power system using adaptive fuzzy sliding mode control

Prakash Ray, Basanta Panigrahi, Pravat Rout, Asit Mohanty, Eddy Foo and Hoay Beng Gooi

DOI: 10.1016/j.asoc.2018.08.033

Abstract: This paper presents design of power system stabiliser (PSS) based on conventional fuzzy-PID and type-1 fuzzy controller for stability improvements in single as well as multimachine power system connected to infinite bus under different loading conditions. Again, fuzzy and integral sliding mode controllers (FSMC and I-SMC) are being incorporated with PSS into the power system to improve the stability performance. But, the presence of chattering in this controller may lead to low frequency oscillations of smaller magnitudes that can sustain to disturb the power transfer capability and the stability of

the system. Therefore, to enhance the performance and efficiency of the power system, a novel adaptive fuzzy sliding mode controller with a robust sliding surface is designed to overcome the possible chattering due to system uncertainties and dynamics. In the proposed adaptive fuzzy sliding mode controller (AFSMC), the stability is ensured through Lyapunov analysis and synthesis test. In addition to the graphical simulation analysis, a quantitative stability approach and real-time test using OPAL-RT OP5600 is also carried out in order to augment the stability study. Further, stability test using eigen modes, root locus and Bode plots are presented to assess the stability performance of the proposed controller. Both the qualitative and quantitative analysis ensures better and robust performance of proposed controllers in comparison to the conventional fuzzy-PID and type-1 fuzzy controller.

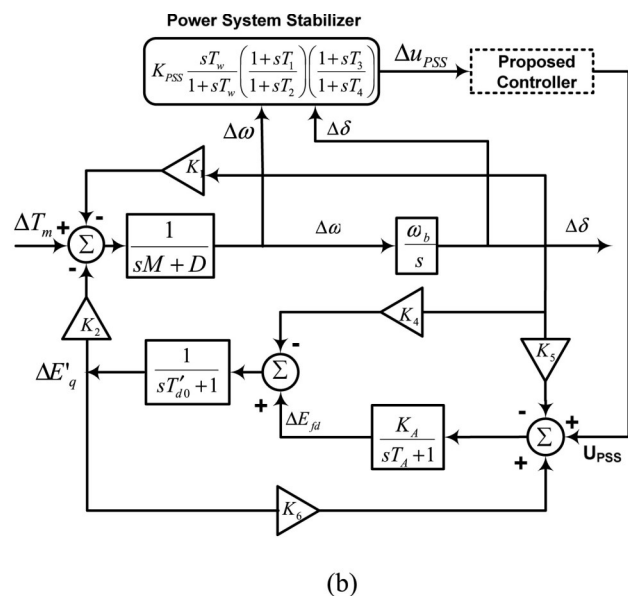
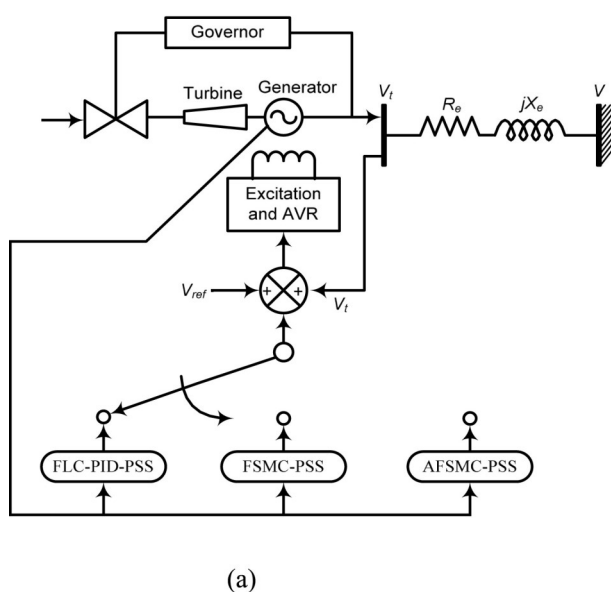

Detection of islanding and fault disturbances in microgrid using wavelet packet transform

Prakash Ray, Basanta Panigrahi, Pravat Rout, Asit Mohanty, Eddy Foo and Hoay Beng Gooi

DOI: 10.1080/03772063.2018.1454344

Abstract: Fast detection of islanding is very important for effective operation and control in distributed generation (DG) penetrated distribution

networks. The islanding detection techniques such as passive, active, communication, and hybrid have their own merits and demerits. This paper proposed wavelet transform (WT) and wavelet packet transform (WPT) based techniques for detection of islanding and fault disturbances in a microgrid consisting of resources like wind turbine generator, fuel cell (FC), and

microturbine. Voltage signal is extracted at the point of common coupling (PCC) and is passed through these detection techniques to obtain the time-frequency multi-resolution analysis. Further, to validate the graphical study, performance indices (PIs) like standard deviation and entropy are calculated for the disturbance detection using suitable selection of threshold. A comparative analysis using WT and WPT is presented in the form of graphical simulation as well as in terms of PIs to analyse their effectiveness and robustness under different operating conditions. It is observed that WPT shows better detection capability in comparison to WT even under 20-dB noisy scenarios.

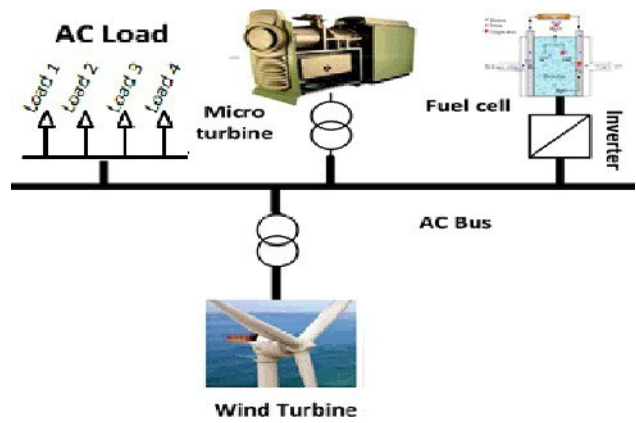

Parameter estimation of solar cells using datasheet information with the application of an adaptive differential evolution algorithm

Partha Biswas, P. N. Suganthan, Guohua Wu and Gehan Amaratunga

DOI: 10.1016/j.renene.2018.07.152

Abstract: A solar cell or photovoltaic (PV) module is electrically represented by an appropriate circuit model with certain defined parameters. The parameters are required to be correctly computed from solar cell characteristic and/or a set of experimental data for simulation and control of the PV system. However, experimental data or accurate characteristic data (i.e. current-voltage or I-V curve) of a PV module may not be readily available. The manufacturer of a PV system usually provides relevant information on open circuit, short circuit and maximum power points. Therefore, an alternate approach is to estimate the PV system parameters by utilising the I-V characteristic data at these three major points. The process involves formulation and solution of complex non-linear equations from an adopted solar cell model. This paper proposes an application of an advanced adaptive differential evolution algorithm on the problem of PV module parameter estimation using minimum available information from the manufacturer datasheet by implementing single-diode and double-diode models. Linear population size reduction tech-

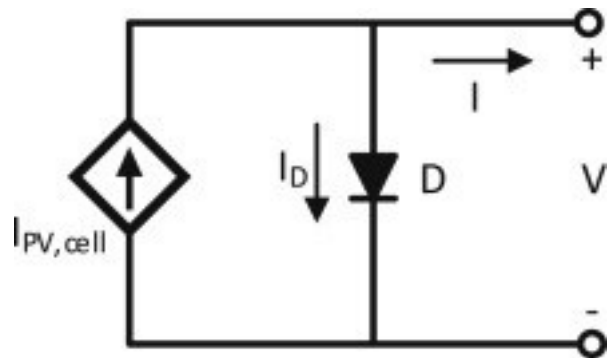

nique of success history based adaptive differential evolution (L-SHADE) algorithm is implemented to minimise the error of current-voltage relationships at the above-mentioned three important points defining the I-V characteristic. The algorithm facilitates evolution of solutions that result in almost zero error ($< 10^{-12}$) at these three major points. All relevant parameters of the PV cell are optimised by the algorithm without any assumption or predetermination of parameters. It is observed that a set of feasible solutions (parameters) is obtained for the PV module from multiple runs of the algorithm. The fact of attaining several probable solutions from datasheet information using few other metaheuristics is also discussed in this work.

Other activities and achievements

Dr Eddy Foo received the NTU early career teaching excellence award in August 2018. He was appointed Topic Co-Chair (Renewable Energy) for the Asian Conference on Energy, Power and Transportation Electrification (ACEPT 2018), held in Singapore in October 2018.

Ashok Krishnan was hosted by Prof. Jan Maciejowski at Pembroke College, Cambridge University in July. During his visit to Cambridge, he interacted with several researchers in the Control Group at Cambridge and discussed possible avenues for future collaboration. On the last day of his visit, he delivered a seminar on his recent work on multi-energy systems titled “Optimal Scheduling of Multi-Energy Systems” to the Control Group.

Prof. Hoay Beng GOOI presented the recent research work at Isolated Power System (IPS) Connect 2018 at Maui, Hawaii in October. He was invited to deliver a Keynote speech entitled, “Hierarchical Transactive Energy Management System for Enhanced Community Market Participation” at 3rd International Conference on New Energy and Applications (CNEA), Singapore during November 2018. He was invited as a speaker in the Panel session, “Internet + Smart Energy” at PowerCon 2018, Guangzhou, China during November.

The paper “Right-half plane zeros are not necessary for inverse response” was presented at the *European Control Conference*, Cyprus, June 2018 by Prof. Maciejowski.

Prof. Maciejowski co-organised the 27th annual Workshop of the European Research Network on System Identification (ERNSI) in Cambridge during September.

Dr Joymala Moirangthem attended the IEEE conference on Environment and Electrical Engineering held in Palermo, Italy in June.

Partha Biswas attended the 2nd International Summer School on Deep Learning 2018 in Genova, Italy.

Dr Bhagyesh Patil organised and chaired a special track on Constraint Programming, Optimization, and Power System Management at the CP 2018 conference in August, Lille, France.

Dr Bhagyesh Patil was invited as a visiting Professor in Prof. Bruno Francois’s group L2EP in École Centrale de Lille, France from August to September 2018.

Prof. Gehan Amaratunga organised an IRP4 Research Review Symposium in Singapore in October to demonstrate some of the work achieved by IRP4 during Phase 1.



eCO₂EP

CARBON CAPTURE AND UTILISATION USING A TABLE-TOP CHEMICAL FACTORY

The aim of the eCO₂EP project is to develop a “table-top chemical factory” that uses electrochemical processes to convert CO₂ into ethylene or to 1-propanol – two molecular products widely used in the chemical industry. Earlier research carried out at CREATE has demonstrated that CO₂ molecules can be transformed into hydrocarbons through the application of electro-catalysis.

eCO₂EP’s research will, among other things, study the viability of scaling CO₂ reduction processes, including techno-economic evaluation of the use of off-peak renewable electricity in areas with excess capacity. The project will allow the exploration of a new energy-chemistry solution for a more sustainable future.

eCO₂EP is led by PIs:

Prof. Alexei Lapkin (CAM)

Prof. Joel Ager (Berkeley)



OVERVIEW

The eCO₂EP project is currently in its months 6-12. During recent months the project team (WP1) has moved and re-installed electrochemical equipment and the team now has all the necessary reaction systems and analytical instrumentation in the CARES lab. The team of researchers is almost complete, with our final research fellow in WP3 arriving late November.

The team in WP1 is also very much looking forward to the delivery in December of a new mass spectrometer to replace the current SIFT system with a PTR-MS, which will give us better time resolution and sensitivity. The project is already

beginning to generate scientific outputs and this, we expect, will rapidly ramp up.

Prof. Alexei Lapkin, PI
University of Cambridge

Prof. Joel Ager, PI
University of California, Berkeley

Update on work package 1

New catalyst discovery and characterisation

Dr Guanyu LIU (Research Fellow, NTU) has successfully synthesised nanostructured catalysts such as CuO, ZnO and Cu-ZnO using a flame system with optimised synthesis parameters. A gas-phase conversion method has been developed to convert flame-made nanoparticulate films to metal-organic framework (MOF) films. This method is compatible with the flame synthesis for large-scale production of catalysts for electrochemical CO₂ reduction. Using this method, flame-made metal oxides have been completely converted to corresponding MOFs. Subsequently, these synthesised catalysts have been character-

ised by scanning electron microscopy (SEM), X-ray diffraction (XRD), transmission electron microscopy (TEM), etc. Their catalytic activities for electrochemical CO₂ reduction have also been tested. Faradaic efficiency of up to 40% has been achieved for ethylene production. To further improve the catalytic activity and selectivity, bimetallic catalysts are currently investigated. Their working mechanisms will be further analysed experimentally and theoretically.

Fig 5.1: Synthesised nanostructured catalysts and their catalytic performance.

Dr Guanyu Liu

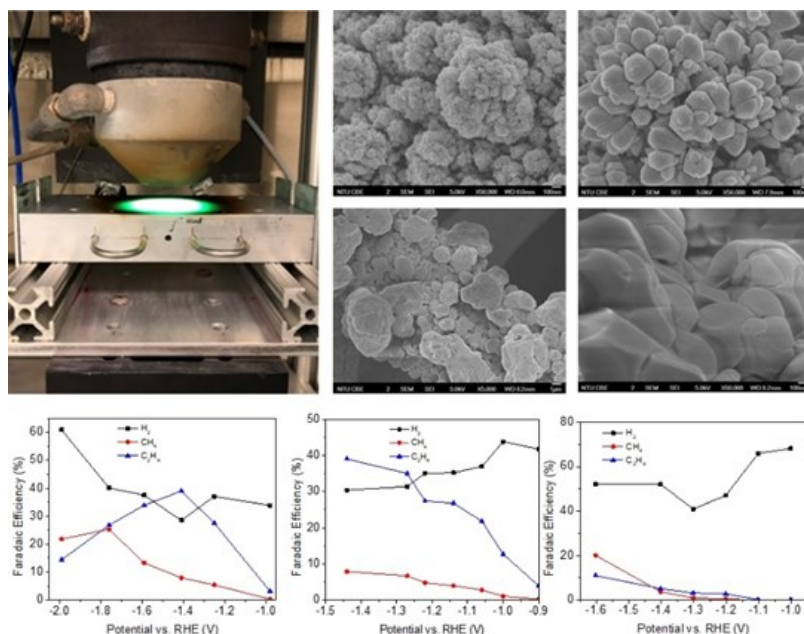

Dr CHEN Yubo (Research Fellow, CARES):

Degree of Geometric Tilting Determines the Activity of FeO₆ Octahedra for Water Oxidation:

Fe oxides and (oxy)hydroxides are promising cost-effective catalysts for scalable water electrolysis. For an improvement in the understanding of the structural factors required by the most active Fe

sites, the role of geometric tilting in determining the activity of the FeO₆ octahedron for water oxidation was investigated. The catalytic performance of the FeO₆ octahedron in a series of crystalline structures, i.e., perovskites AFeO₃, spinel ZnFe₂O₄, and β-FeOOH, was found to be negatively correlated with their octahedral tilting degree. This correlation was rationalised through the Fe-O covalency, which is reflected by the O 2p band centre as well as the charge-transfer energy obtained from ab initio calculations. Thus, it was disclosed that FeO₆ octahedral tilting alters the activity for water oxidation through changing the covalency degree of Fe-O bonds.

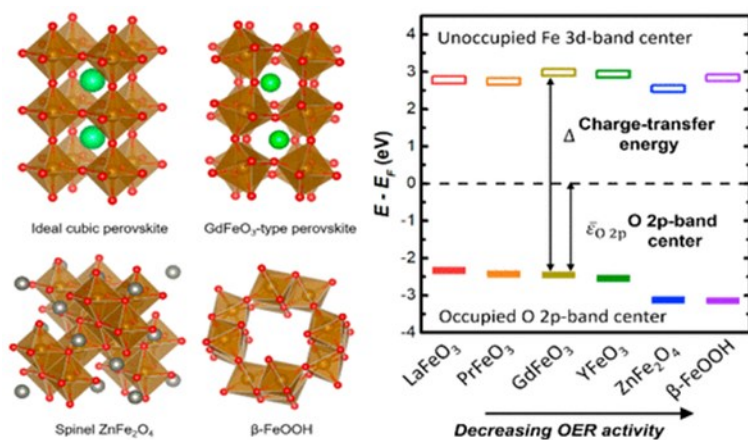

Dr Divya Nagaraj (Research Fellow, NUS) has been working on developing catalysts for the utilisation of CO₂ as chemical feedstock for value-added products which further can pave the path for mitigating increased greenhouse gas. Electrochemical conversion of CO₂ is the most efficient way of producing industrial feedstocks. However, producing higher hydrocarbon ($\geq C_2$) gaseous and liquid products with high selectivity, high faradaic efficiency and low activation over potential is still a challenge. She is focusing on developing an appropriate design of the catalyst with

suitable morphology that can address the challenge by producing $\geq C_2$ products. She is also studying the effect of adding dopants into the lattice or the sub-lattice of the catalyst, which is another approach for obtaining $\geq C_2$ products. Once the products are formed, she will characterise and measure the products both quantitatively and qualitatively using online GC (for gaseous products), HPLC (for liquid products) and real time monitoring using PTR-MS TOF (for both liquid and gaseous products) respectively.

Update on work package 2

Modelling and data informatics

Under the supervision of Dr Matthew Sherburne, Dr Quang Thang (Victor) Trinh (Research Fellow, NTU) has worked on computational studies to guide the design of more efficient catalysts for CO₂ reduction, based on density functional theory (DFT) calculations. His previous study in C4T's IRP1 predicted that a novel boron-doped Cu catalyst (called B-Cu) would facilitate the C-C coupling and enhance the yield of C₂ products. Inspired by the DFT prediction, Dr Lily Mandal has synthesised the B-Cu catalyst by depositing boron on a copper surface followed by annealing. Preliminary results show that B has indeed been incorporated into interstitial sites in the Cu lattice, and the as-synthesised B-Cu performs well for CO₂ reduction with the faradaic efficiency for ethylene formation approaching 50%, significantly larger than for pure Cu. Further optimisation of the catalyst design and manufacturing is currently underway.

Dr Trinh also developed a method based on DFT simulations of X-ray photoelectron spectroscopy (XPS) as a tool to characterise catalysts for CO₂ reduction. A case study of CuO, as a model catalyst, demonstrated an integrated experimental (XPS) and theoretical (DFT+U) approach to investigate surface catalysis on transition metal oxides (TMOs), can be an effective approach to understanding surfaces of alloyed catalyst. Standalone density functional theory (DFT) and experimental surface characterisation techniques are widely used to provide insights into reaction mechanisms and pathways for TMO catalysed reactions. However, in order to investigate reactions and catalysts under real operating conditions, it is vital to develop novel approaches that integrate the surface sensitive experimental techniques and theoretical tools, thus paving the way for the design and development of more active and selec-

tive TMO-based catalysts. Additionally, the synergistic application of DFT and surface characterisation methods presents a tremendous potential to overcome challenges arising from their solitary application to study catalysis. Using this integrated approach, this has allowed the simultaneous (i) determine the optimum U value for performing DFT calculations (benchmarking DFT methods) of TMO surface catalysed reactions, and, (ii) identify and assign adsorbate/intermediate species to experimentally observed XPS peaks. The comparison of DFT+U computed and experimentally measured CLBEs provides the correct U value for DFT and in the process of U value determination, known and unknown surface moieties and their configurations are identified and correlated to corresponding XPS shifts. This method should be extendable to additional surface science techniques such as *in situ* and temperature programmed XPS, for more accurate determination and prediction of reaction mechanisms, pathways, catalytic active sites and thus guide the design and development of efficient and novel TMO based catalysts. The paper based on those results has been accepted for publication on *The Journal of Physical Chemistry C*.

Martin (Research Scientist, CARES) has completed literature reviews on electrochemical systems in general, particularly flow reactors for converting CO₂ into useful products with the help of electricity. As a mathematical modeller and software developer, all the work involved is developing, maintaining and extending existing chemical kinetics software to include capabilities of electrochemistry. This software will be used to optimise the macro kinetics reaction pathways, which will be in the order of hundreds of elementary reactions when converting from CO₂ into ethylene and 1-propanol.

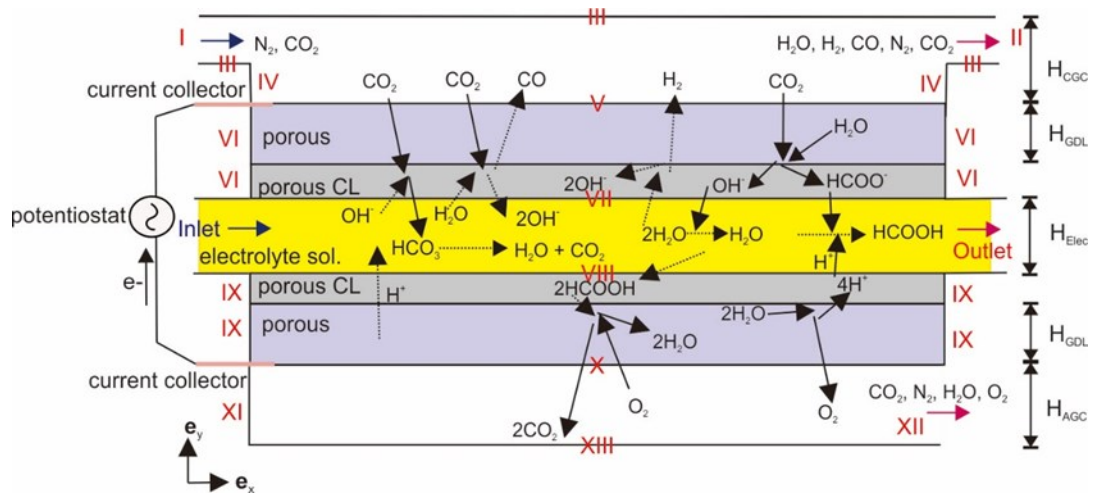

Fig. 5.2: Flow Reactor for CO₂ conversion. H_{CGC} is the cathode gas channel, H_{GDL} is the gas diffusion layer (both anode and cathode), H_{Elec} is the electrolyte channel and H_{AGD} is the anode gas channel. Furthermore, the roman numerals define the boundary conditions of the fluids and chemistry inside this reactor. **I** Cathode gas channel inlet. **II** Cathode gas channel outlet. **III** Cathode gas channel horizontal walls. **IV** Cathode gas channel vertical walls. **V** Cathode gas-channel-GDL interface. **VI** Cathode GDE vertical walls. **VII** Cathode CL-electrolyte interface. **VIII** Anode CL-electrolyte interface. **IX** Anode GDE vertical walls. **X** Anode gas-channel-GDL interface. **XI** Anode gas channel wall/inlet. **XII** Anode gas channel wall/outlet. **XIII** Anode gas channel wall/opening.

Martin

Figure 5.2 has been adapted from many recent publications on reactor flow for CO₂ conversion to CO only. In the figure, there exists many chemical species as products of CO₂ conversion. In Martin’s research, there will be even more species because of multiple reaction pathways. To determine which of the elementary reactions are relevant to the expected end products, he will collaborate with those working on DFT to get the reaction rate constant for each of the elementary process and to list all the reactions that have high probabilities of occurrence. He will also the soft-

ware in order to be able to model the electrochemistry process where there are ions (current) involved.

Dr Kuppa Ashoke Raman (Research Fellow, NUS):

Transport modelling of an electrochemical reactor: A base model of a reactor used for the electrochemical conversion of CO₂ to CO has been developed. The cell design is similar to that of a Proton Exchange Membrane (PEM) fuel cell. However, instead of using a membrane as the

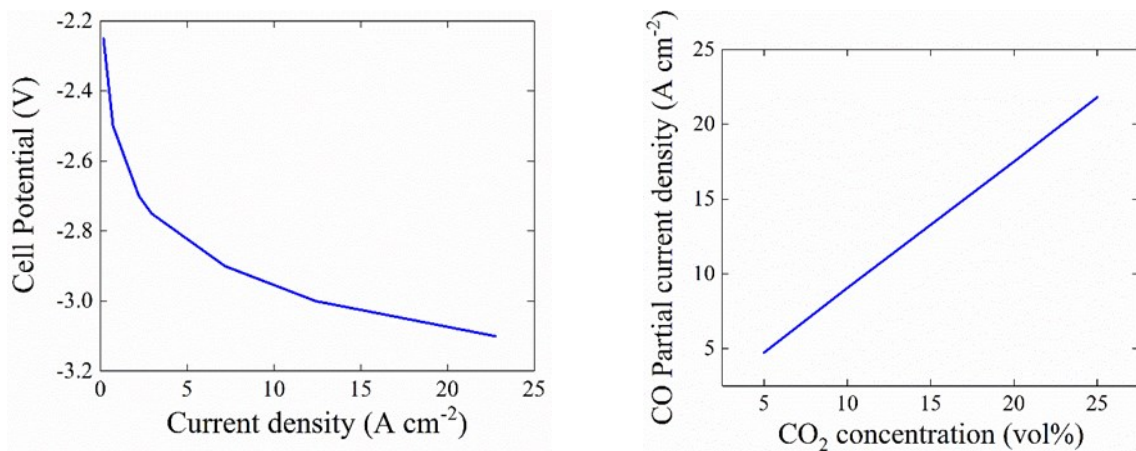

Fig. 5.3: **left** The polarisation curve. **right** The partial current density for CO as a function of input CO₂ concentration by volume.

Dr Kuppa Ashoke Raman

electrolyte, we adopt a continuous flowing electrolyte channel. The test cell design consists of a gas flow channel, gas diffusion layer and the catalyst layer on the cathode side. Similar configuration is adapted on the anode side as well, however, for the present test case we have assumed the anode gas channel to be open. Both these electrodes are separated by a flowing electrolyte channel. A complete set of transport equations for the fluid flow, mass transfer and charge transport are solved using a finite element based

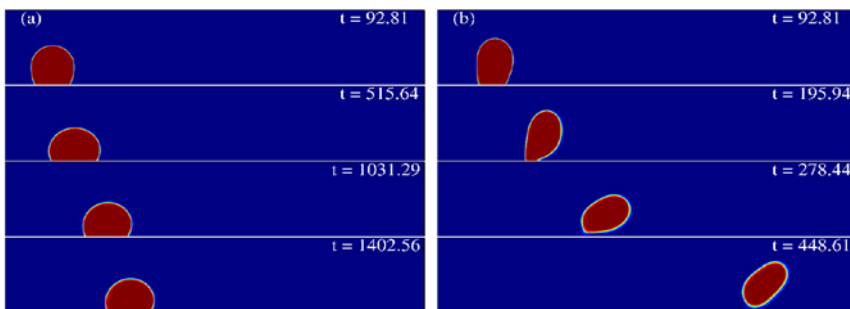

Figure 5.4: Temporal sequence of different transient behaviour in droplet morphology with amplitude (a) $Ua = 0.0209$ and (b) $Ua = 0.0669$ at pulsating frequency of 0.2.

Dr Kuppa Ashoke Raman

Modelling water flooding inside the gas flow channel: The reactions taking place inside the reactor are dependent on the rate of electron transfer and mass transfer of the reacting species to the catalyst. One of the way to enhance mass transfer is to use a pulsating flow into the gas feed channel. In case of production of liquid products, a common occurrence is the problem of water flooding inside the gas channel.

To investigate the behaviour of such flows occurring in the gas feed channel, a numerical investi-

gation on the motion of a droplet resting on the surface of the flow channel is performed using the lattice Boltzmann method. The effect of varying pulse amplitudes and frequency of the droplet dynamics is studied. A phase regime diagram is constructed which shows droplet the final outcome of droplet resting or detachment with varying amplitudes and frequencies. This work will be extended to a more general case of droplet motion on a rough surface.

Update on work package 3 Chemical factory on a table

Dr Krishna Gudena's (Research Fellow, CARES) research interest lies in plantwide design, optimisation, advanced control and techno-economic analysis of large-scale process systems.

Dr Gudena is primarily responsible for developing the specifications of the table-top factory, developing its automation and control system, integrating the reaction and the separation components, developing process data storage and analysis solutions and performing the techno-economic analysis. He is also responsible for tracking the timeline of delivery of the individual components for the integrated table-top factory, identifying and commissioning contractors. Due

to the multi-faceted nature of his work, Dr Gudena works closely with the team that is developing new electrodes and scaling up the electrochemical cell, and with researchers working on product separation. The final objective for his work is to achieve the integration of the components of the electrochemical CO_2 conversion system into a functional demonstration device, and the operation of the table-top chemical factory.

As progress in this direction, the methods to obtain the complete table-top factory flowsheet are currently being worked on. A surrogate reactor model based on the WP2 Comsol model or an equivalent yield reactor based on the experi-

mental data from WP1 will be used to initiate the reactor modelling in Aspen. The validity of the thermodynamics and the physical properties that are the key for the reliable plant model are being tested. On the separation front, an adsorption process will be used to selectively remove and maximise the desired product of interest. Since adsorption is a dynamic phenomenon, a time-dependent model for the product separation will be built and further validated. Each of the independent units from the table-top factory model will be validated before proceeding with optimisation and control of the process. Scale-up, product separation and efficient use of CO₂ to maximise the product yield are the key challenges in large-scale chemical processes, and this part of the study will help considerably in analysing the information found. Plantwide CAPEX/OPEX modelling and techno-economic analysis will then follow. The techno-economic analysis will be subjected to sensitivity and uncertainty tests for multi-scenario analysis and to provide further insight into this process.

Dr Souradip Malkhandi (Research Fellow, NUS) has been working on the design and development of a table-top CO₂ electrolyser. Electro-reduction of CO₂ is not only another method for carbon sequestration, but also a potential eco-friendly process for the production of value-added chemicals such as ethylene, ethanol, methanol and propanol. Until now most of the research on the electro-reduction of CO₂ has been focused on the development of the catalysts and understanding of the catalytic reaction mechanism. Usually, such research is carried out in a model electrochemical system, where the electrochemical reactions are studied on a highly controlled small electrode surface (less than 1 cm²) at

few milliamp of current density. Although model electrochemical studies are good for understanding the science behind this, it is not practically useful for generating a significant amount of products.

Consequently, that limitation makes techno-economic modelling and feasibility studies difficult, if not impossible. The development of a table-top CO₂ electrolyser will be the next logical progression to show how the results of model electrochemical study will be reflected in a practical and small but industrial-type electrochemical system. Keeping in mind all these factors, Dr Malkhandi is developing an electrolyser with a scale factor of 100, i.e. electrode size 100 cm², which will be operated at a current density of several hundred milliamps/cm². This table-top reactor will be designed to generate products in quantities that are multiple orders of magnitude higher than model electrochemical systems. In the reporting period, Dr Malkhandi worked towards setting up the specifications, designing the table-top reactor and associated fluid control system, computerised measurements and control system for the electrolyser and procuring components.

Fig. 5.5: Proposed table-top CO₂ electrolyser.

Dr Souradip Malkhandi

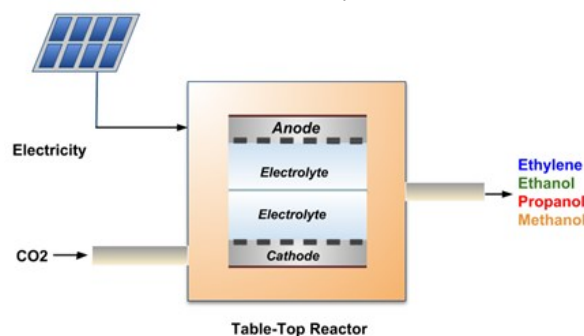

Scientific output

Metal-oxygen Hybridization Determined Activity in Spinel-based Oxygen Evolution Catalysts: A Case Study of ZnFe_{2-x}Cr_xO₄

Haiyan Li, Shengnan Sun, Shibo Xi, Yubo Chen, Ting Wang, Yonghua Du, Matthew Sherburne, Joel Ager, Adrian Fisher and Zhichuan Xu

DOI: 10.1021/acs.chemmater.8b02871

Abstract: A good understanding of the correlation between electronic properties and catalytic performance is vital to the rational design of active oxygen evolution reaction (OER) catalysts. Here, a volcano-shaped correlation between the OER activity and the Cr substitution amount was found for spinel oxides ZnFe_{2-x}Cr_xO₄ ($x = 0-2$), in which Zn²⁺ resides in tetrahedral (Td) sites while

Fe^{3+} and Cr^{3+} occupy octahedral (Oh) sites. Such a relationship probably is because Cr substitution tunes the e_g occupancy of Oh-site transition metals (TM_{Oh}) via the Oh-Oh superexchange effect. Density functional calculations further revealed the hybridisation degree between the TM_{Oh} 3d and the O 2p states, and a volcano-shaped trend was also found in the variation of TM_{Oh} 3d-O 2p hybridisation with the amount of Cr substitution. The good correlation between the OER activity and the hybridisation highlights the important role of metal

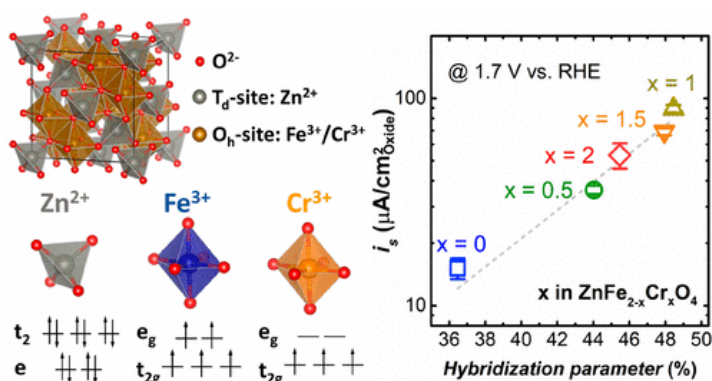

–oxygen hybridisation in determining the OER activity of these spinel oxides.

Chemical storage of renewable energy

Joel Ager and Alexei Lapkin

DOI: 10.1126/science.aat7918

Abstract: The conversion of carbon dioxide (CO_2) into fuels and chemicals using renewable energy is a potential pathway to mitigate increasing CO_2 concentration in the atmosphere and acidification of the oceans. In a process that is essentially the reverse of combustion and is analogous to photosynthesis, CO_2 can be electrochemically reduced to hydrocarbons by using renewable power sources such as wind and solar. This process would not compete with direct use of renewable energy as electricity, as the objective is to store excess energy for later use. On page 783 of this issue, Dinh *et al.* show that ethylene can be generated selectively via electrochemical CO_2 reduction at rates that could yield a technologically feasible process. The thermodynamics of reduc-

ing CO_2 are similar to those of splitting water into hydrogen and oxygen, which has been done commercially with an energetic efficiency as high as 80%. However, CO_2 reduction is considerably more challenging because of the unreactive nature of the CO_2 molecule and the demands of controlling multiple electron and proton transfer events (12, in the case of ethylene) on the surface of the electrocatalyst. Copper catalysts bind carbon monoxide (CO) and other reaction intermediates in such a way as to produce two-carbon products such as ethylene and ethanol. However, it has been difficult to steer the reaction toward any one product. Moreover, most experimental studies provide CO_2 to the electrode from aqueous solution, where its finite solubility leads to an upper, diffusion-limited current density of a few tens of milliamperes per square centimetre—far below what would be commercially relevant.

Other activities and achievements

Dr Quang Thang Trinh (Research Fellow, NTU) was invited to attend and deliver a keynote speech at the RoHan DAAD SDG Workshop 2018: Catalysis Toward Sustainable Chemical Industry, which took place at the Hanoi University of Science and Technology, Vietnam in September 2018. The workshop was co-organised by the University of Rostock, the Leibniz Institute for Catalysis as well as the Hanoi University of Science and Technology (HUST) and the Hanoi University of Science (VNU-HUS). Dr Trinh's talk "Computational guided design of catalyst for sustainable and green energy" was well received by the audience.



Dr Trinh giving his keynote presentation.

economically, and in an en
[]. At a higher level of abst
ging, even in a process of r
But at the lower levels, n
es of reliability, being ex
nsible, etc., depend on th
e challenges in grid mode
configuration. That is, mi
ve existing grid smarter, l
management for the new
on.
that consumers with l
ties can become "pro

ARTICLE
DOI: 10.1038/s41467-018-06269-z OPEN

Hydrogen spillover through Matryoshka-type (ZIFs@)_{n-1}ZIFs nanocubes

Guowu Zhan^{1,2} & Hua Chun Zeng^{1,2}

Hydrogen spillover ph
highly disputed in hyd
metal-

PUBLICATIONS

Energy 150 (2018) 1039–1057

Contents lists available at ScienceDirect

Energy

al homepage: www.elsevier.com/locate/energy

environmental power dispatch with
all hydro power

an^a, B.Y. Qu^b, Gehan A.J. Amaratunga^c

g Technological University, Singapore
yuan University of Technology, China

H₂O₂ Production

Selective Electrochemical H₂O₂ Two-Electron Oxygen Electro

Yuan Yuan Jiang, Pengjuan Ni, Chuanxia Che,
Biao Kong, Adrian Fisher, and Xin Wang*

Direct electrochemical production of hydrogen peroxide (H₂O₂)
two-electron oxygen electrochemistry, for example, the oxygen re
in fuel cells or water oxidation in water electrolyzers, could provi
attractive alternative to locally produce this chemical on demand
efficiency of these processes depends greatly
effective catalysts with h

ALL C4T PUBLICATIONS WITH CREATE ACKNOWLEDGEMENT

C4T joint IRP publications

IRP1 and IRP2

- Xie, Ming Shi, Bao Yu Xia, Yawei Li, Ya Yan, Yanhui Yang, Qiang Sun, Siew Hwa Chan, Adrian C. Fisher, and Xin Wang. 2016. "Amino Acid Modified Copper Electrodes for the Enhanced Selective Electroreduction of Carbon Dioxide towards Hydrocarbons." *Energy Environ. Sci.*, no. 5: 1687–95. <https://doi.org/10.1039/C5EE03694A>.
- Yan, Yibo, Jianwei Miao, Zhihong Yang, Fang-Xing Xiao, Hong Bin Yang, Bin Liu, and Yanhui Yang. 2015. "Carbon Nanotube Catalysts: Recent Advances in Synthesis, Characterization and Applications." *Chem. Soc. Rev.* 44 (10): 3295–3346. <https://doi.org/10.1039/C4CS00492B>.

IRP1 and IRP3

- Amaniampong, Prince N., Quang Thang Trinh, Kaixin Li, Samir H. Mushrif, Yu Hao, and Yanhui Yang. 2017. "Porous Structured CuO-CeO₂ Nanospheres for the Direct Oxidation of Cellobiose and Glucose to Gluconic Acid." *Catalysis Today*, January. <https://doi.org/10.1016/j.cattod.2017.01.009>.
- Amaniampong, Prince N., Quang Thang Trinh, Bo Wang, Armando Borgna, Yanhui Yang, and Samir H. Mushrif. 2015. "Biomass Oxidation: Formyl C-H Bond Activation by the Surface Lattice Oxygen of Regenerative CuO Nanoleaves." *Angewandte Chemie International Edition* 54 (31): 8928–33. <https://doi.org/10.1002/anie.201503916>.
- Amaniampong, Prince Nana, Amin Yoosefi Booshehri, Xinli Jia, Yihu Dai, Bo Wang, Samir H. Mushrif, and Armando Borgna. 2015. "High-Temperature Reduction Improves the Activity of Rutile TiO₂ Nanowires-Supported Gold-Copper Bimetallic Nanoparticles for Cellobiose to Gluconic Acid Conversion." *Applied Catalysis A: General* 505 (September): 16–27. <https://doi.org/10.1016/j.apcata.2015.07.027>.
- Azadi, Pooya, George Brownbridge, Immanuel Kemp, Sebastian Mosbach, John S. Dennis, and Markus Kraft. 2015. "Microkinetic Modeling of the Fischer-Tropsch Synthesis over Cobalt Catalysts." *ChemCatChem* 7 (1): 137–43. <https://doi.org/10.1002/cctc.201402662>.

IRP1 and IRP4

- Yang, Shiliang, Andy Cahyadi, Yuhao Sun, Jingwei Wang, and Jia Wei Chew. 2016. "CFD-DEM Investigation into the Scaling up of Spout-Fluid Beds via Two Interconnected Chambers." *AIChE Journal* 62 (6): 1898–1916. <https://doi.org/10.1002/aic.15188>.
- Yang, Shiliang, Yuhao Sun, Jingwei Wang, Andy Cahyadi, and Jia Wei Chew. 2015. "Influence of Operating Parameters and Flow Regime on Solid Dispersion Behavior in a Gas-Solid Spout-Fluid Bed." *Chemical Engineering Science* 142: 112–25. <http://dx.doi.org/10.1016/j.ces.2015.11.038>.
- Yang, Shiliang, Yuhao Sun, Liangqi Zhang, and Jia Wei Chew. 2016. "Computational Study of the Effect of Draft Plates on the Solid Behavior in a Spout-Fluid Bed." *Industrial & Engineering Chemistry Research* 49 (55): 12598–615. <https://doi.org/10.1021/acs.iecr.6b02732>.
- Yang, Shiliang, Yuhao Sun, Liangqi Zhang, and Jia Wei Chew. 2017. "Improving the Operational Stability of the Multi-Chamber Spout-Fluid Bed via the Insertion of a Submerged Partition Plate." *AIChE Journal* 63 (2): 485–500. <https://doi.org/10.1002/aic.15427>.
- Yang, Shiliang, Yuhao Sun, Liangqi Zhang, Ya Zhao, and Jia Wei Chew. 2016. "Numerical Investigation on the Effect of Draft Plates on Spouting Stability and Gas-Solid Characteristics in a Spout-Fluid Bed." *Chemical Engineering Science*, March. <https://doi.org/10.1016/j.ces.2016.03.010>.

IRP3 and IRP4

- Chen, Tengpeng, Dexiang Zhou, Tri Tran, Catharine Kastner, K. V. Ling, K-J. Tseng, and Jan M. Maciejowski. 2015. "Distributed Moving Horizon Estimation for Power Systems." In , 1–5. IEEE. <https://doi.org/10.1109/PESGM.2015.7286281>.
- Li, Kaixin, Zhihong Yang, Jun Zhao, Junxi Lei, Xinli Jia, Samir H. Mushrif, and Yanhui Yang. 2015. "Mechanistic and Kinetic Studies on Biodiesel Production Catalyzed by an Efficient Pyridinium Based Ionic Liquid." *Green Chem.* 17 (8): 4271–80. <https://doi.org/10.1039/C5GC00976F>.
- Trinh, Quang Thang, Arghya Banerjee, Yanhui Yang, and Samir H. Mushrif. 2016. "Sub-Surface Boron-Doped Copper for Methane Activation and Coupling: First-Principles Investigation of the Structure, Activity, and Selectivity of the Catalyst." *The Journal of Physical Chemistry C* 121 (2): 1099–1112. <https://doi.org/10.1021/acs.jpcc.6b09236>.

C4T IRP1 — MUSCAT

- Amaniampong, Prince N., Quang Thang Trinh, Jithin John Varghese, Ronan Behling, Sabine Valange, Samir H. Mushrif, and Francois Jérôme. 2018. "Unraveling the Mechanism of the Oxidation of Glycerol to Dicarboxylic Acids over a Sonochemically Synthesized Copper Oxide Catalyst." *Green Chemistry* 20 (12): 2730–41. <https://doi.org/10.1039/C8GC00961A>.
- Amaniampong, Prince Nana, Amin Yoosefi Booshehri, Xinli Jia, Yihu Dai, Bo Wang, Samir H. Mushrif, and Armando Borgna. 2015. "High-Temperature Reduction Improves the Activity of Rutile TiO₂ Nanowires-Supported Gold-Copper Bimetallic Nanoparticles for Cellobiose to Gluconic Acid Conversion." *Applied Catalysis A: General* 505 (September): 16–27. <https://doi.org/10.1016/j.apcata.2015.07.027>.
- Bhola, Kartavya, Jithin John Varghese, Liu Dapeng, Yan Liu, and Samir H. Mushrif. 2017. "Influence of Hubbard U Parameter in Simulating Adsorption and Reactivity on CuO: Combined Theoretical and Experimental Study." *The Journal of Physical Chemistry C* 121 (39): 21343–53. <https://doi.org/10.1021/acs.jpcc.7b05385>.
- Cahyadi, Andy, Aditya Anantharaman, Shiliang Yang, S. B. Reddy Karri, John G. Findlay, Ray A. Cocco, and Jia Wei Chew. 2016. "Review of Cluster Characteristics in Circulating Fluidized Bed (CFB) Risers." *Chemical Engineering Science*, no. 158: 70–95. <https://doi.org/10.1016/j.ces.2016.10.002>.
- Chan, Martin SC, Wen Liu, Mohammad Ismail, Yanhui Yang, Stuart Scott, and John Dennis. 2016. "Improving Hydrogen Yields, and Hydrogen: Steam Ratio in the Chemical Looping Production

of Hydrogen Using $\text{Ca}_2\text{Fe}_2\text{O}_5$." *Chemical Engineering Journal* 296 (July): 406–11. <https://doi.org/10.1016/j.cej.2016.03.132>.

- Chen, Hong, Yihu Dai, Xinli Jia, Hao Yu, and Yanhui Yang. 2016. "Highly Selective Gas-Phase Oxidation of Ethanol to Ethyl Acetate over Bi-Functional Pd/Zelite Catalysts." *Green Chemistry*, February. <https://doi.org/10.1039/C5GC02593A>.
- Chunmiao, Jia, Gao Jiajian, Dai Yihu, Zhang Jia, and Yang Yanhui. 2016. "The Thermodynamics Analysis and Experimental Validation for Complicated Systems in CO_2 Hydrogenation Process." *Journal of Energy Chemistry* 25 (6): 1027–37. <https://doi.org/10.1016/j.jechem.2016.10.003>.
- Dai, Yihu, Ye Wang, Bin Liu, and Yanhui Yang. 2015. "Metallic Nanocatalysis: An Accelerating Seamless Integration with Nanotechnology." *Small* 11 (3): 268–89. <https://doi.org/10.1002/smll.201400847>.
- Dai, Yihu, Xinping Wu, Yu Tang, Yanhui Yang, Xueqing Gong, and Jie Fan. 2015. "Selectivity Switching Resulting in the Formation of Benzene by Surface Carbonates on Ceria in Catalytic Gas-Phase Oxidation of Benzyl Alcohol." *Chemical Communications* 52 (13): 2827–30. <https://doi.org/10.1039/C5CC08904B>.
- Dou, Jian, Yuan Sheng, Catherine Choong, Luwei Chen, and Hua Chun Zeng. 2017. "Silica Nanowires Encapsulated Ru Nanoparticles as Stable Nanocatalysts for Selective Hydrogenation of CO_2 to CO ." *Applied Catalysis B: Environmental* 219 (December): 580–91. <https://doi.org/10.1016/j.apcatb.2017.07.083>.
- Dunstan, Matthew, Serena Maugeri, Wen Liu, Matthew Tucker, Oluwadamilola Taiwo, Belen Gonzalez, Phoebe Allan, et al. 2016. "In Situ Studies of Materials for High Temperature CO_2 Capture and Storage." *Faraday Discussion*, April. <https://doi.org/10.1039/C6FD00047A>.
- Dunstan, Matthew T., Anubhav Jain, Wen Liu, Shyue Ping Ong, Tao Liu, Jeongjae Lee, Kristin A. Persson, Stuart A. Scott, John S. Dennis, and Clare P. Grey. 2016. "Large Scale Computational Screening and Experimental Discovery of Novel Materials for High Temperature CO_2 Capture." *Energy & Environmental Science*, February. <https://doi.org/10.1039/C5EE03253A>.
- González, Belén, Wen Liu, D. Saquib Sultan, and J. S. Dennis. 2016. "The Effect of Steam on a Synthetic Ca-Based Sorbent for Carbon Capture." *Chemical Engineering Journal* 285 (February): 378–83. <https://doi.org/10.1016/j.cej.2015.09.107>.
- He, Chao, Ke Wang, Apostolos Giannis, Yanhui Yang, and Jing-Yuan Wang. 2015. "Products Evolution during Hydrothermal Conversion of Dewatered Sewage Sludge in Sub- and near-Critical Water: Effects of Reaction Conditions and Calcium Oxide Additive." *International Journal of Hydrogen Energy* 40 (17): 5776–87. <https://doi.org/10.1016/j.ijhydene.2015.03.006>.
- He, Chao, Ke Wang, Yanhui Yang, Prince N. Amaniampong, and Jing-Yuan Wang. 2015. "Effective Nitrogen Removal and Recovery from Dewatered Sewage Sludge Using a Novel Integrated System of Accelerated Hydrothermal Deamination and Air Stripping." *Environmental Science & Technology* 49 (11): 6872–80. <https://doi.org/10.1021/acs.est.5b00652>.
- He, Chao, Jun Zhao, Yanhui Yang, and Jing-Yuan Wang. 2016. "Multiscale Characteristics Dynamics of Hydrochar from Hydrothermal Conversion of Sewage Sludge under Sub- and near-Critical Water." *Bioresour Technol* 211 (July): 486–93. <https://doi.org/10.1016/j.biortech.2016.03.110>.
- Helmdach, Daniel, Polina Yaseneva, Parminder K. Heer, Artur M. Schweidtmann, and Alexei Lapkin. 2017. "A Multiobjective Optimization Including Results of Life Cycle Assessment in Developing Biorenewables-Based Processes." *ChemSusChem* 10 (8): 3632–43. <https://doi.org/10.1002/cssc.201700927>.
- Huang, Jijiang, Wen Liu, and Yanhui Yang. 2017. "Phase Interactions in Mg-Ni-Al-O Oxygen Carriers for Chemical Looping Applications." *Chemical Engineering Journal* 326 (October): 470–76. <https://doi.org/10.1016/j.cej.2017.05.176>.
- Huang, Jijiang, Wen Liu, Yanhui Yang, and Bin Liu. 2018. "High-Performance Ni-Fe Redox Catalysts for Selective CH_4 to Syngas Conversion via Chemical Looping" 8: 1748–1756. <https://doi.org/10.1021/acscatal.7b03964>.
- Ismail, Mohammad, Wen Liu, Martin S.C. Chan, Matthew T. Dunstan, and Stuart A. Scott. 2016. "Synthesis, Application, and Carbonation Behavior of $\text{Ca}_2\text{Fe}_2\text{O}_5$ for Chemical Looping H_2 Production." *Energy & Fuels* 30 (8): 6220–32. <https://doi.org/10.1021/acs.energyfuels.6b00631>.

- Ismail, Mohammad, Wen Liu, Matthew T. Dunstan, and Stuart A. Scott. 2016. "Development and Performance of Iron Based Oxygen Carriers Containing Calcium Ferrites for Chemical Looping Combustion and Production of Hydrogen." *International Journal of Hydrogen Energy* 41 (7): 4073–84. <https://doi.org/10.1016/j.ijhydene.2015.11.066>.
- Jose, Nicholas, and Alexei Lapkin. 2019. "Influence of Hydrodynamics on Wet Syntheses of Nanomaterials." In *Advanced Nanomaterials for Catalysis and Energy*, 29–59. Elsevier. <https://doi.org/10.1016/B978-0-12-814807-5.00002-4>.
- Kwok, Kelvin Mingyao, Sze Wei Daniel Ong, Luwei Chen, and Hua Chun Zeng. 2018. "Constrained Growth of MoS₂ Nanosheets within a Mesoporous Silica Shell and Its Effects on Defect Sites and Catalyst Stability for H₂S Decomposition." *ACS Catalysis* 8 (1): 714–24. <https://doi.org/10.1021/acscatal.7b03123>.
- Li, Bowen, and Hua Chun Zeng. 2018a. "Formation-Cum-Intercalation of Ni and Its Alloy Nanoparticles within Mesoporous Silica for Robust Catalytic Reactions." *ACS Applied Materials & Interfaces*, August. <https://doi.org/10.1021/acscami.8b07896>.
- Li, Bowen, and Hua Chun Zeng. 2018b. "Architecture and Preparation of Hollow Catalytic Devices." *Advanced Materials*, August, 1801104. <https://doi.org/10.1002/adma.201801104>.
- Li, Kaixin, Zhihong Yang, Jun Zhao, Junxi Lei, Xinli Jia, Samir H. Mushrif, and Yanhui Yang. 2015. "Mechanistic and Kinetic Studies on Biodiesel Production Catalyzed by an Efficient Pyridinium Based Ionic Liquid." *Green Chem.* 17 (8): 4271–80. <https://doi.org/10.1039/C5GC00976F>.
- Li, Ping, and Hua Chun Zeng. 2016a. "Immobilization of Metal–Organic Framework Nanocrystals for Advanced Design of Supported Nanocatalysts." *ACS Appl. Mater. Interfaces* 8: 29551–64. <https://doi.org/10.1021/acscami.6b11775>.
- Li, Ping, and Hua Chun Zeng. 2016b. "Ultrafine Alloy Nanoparticles Converted from 2D Intercalated Coordination Polymers for Catalytic Application." *Advanced Functional Materials*, 5658–68. <https://doi.org/10.1002/adfm.201601174>.
- Li, Ping, and Hua Chun Zeng. 2017a. "Hierarchical Nanocomposite by the Integration of Reduced Graphene Oxide and Amorphous Carbon with Ultrafine MgO Nanocrystallites for Enhanced CO₂ Capture." *Environ. Sci. Technol.* 51 (21): 12998–13007. <https://doi.org/10.1021/acs.est.7b03308>.
- Li, Ping, and Hua Chun Zeng. 2017b. "Synthetic Architecture of MgO/C Nanocomposite from Hierarchical-Structured Coordination Polymer towards Enhanced CO₂ Capture." *ACS Appl. Mater. Interfaces* 9 (March). <https://doi.org/10.1021/acscami.6b14960>.
- Li, Ping, and Hua Chun Zeng. 2017c. "Sandwich-like Nanocomposite of CoNiOx/Reduced Graphene Oxide for Enhanced Electrocatalytic Water Oxidation." *Advanced Functional Materials* 27 (13): 1606325–35. <https://doi.org/10.1002/adfm.201606325>.
- Li, Ping, and Hua Chun Zeng. 2017d. "Advanced Oxygen Evolution Catalysis by Bimetallic Ni-Fe Phosphide Nanoparticles Encapsulated in Nitrogen, Phosphorus, and Sulfur Tri-Doped Porous Carbon." *Chemical Communications* 53 (44): 6025–28. <https://doi.org/10.1039/C7CC03005C>.
- Li, Ping, and Hua Chun Zeng. 2018. "Bimetallic Ni-Fe Phosphide Nanocomposites with Controlled Architecture and Composition Enabling Highly Efficient Electrochemical Water Oxidation." *Journal of Materials Chemistry A* 6 (5): 2231–38. <https://doi.org/10.1039/C7TA10665C>.
- Liu, Wen, Belén González, Matthew T. Dunstan, D. Saquib Sultan, Adriano Pavan, Chris D. Ling, Clare P. Grey, and J. S. Dennis. 2016. "Structural Evolution in Synthetic, Ca-Based Sorbents for Carbon Capture." *Chemical Engineering Science* 139 (January): 15–26. <https://doi.org/10.1016/j.ces.2015.09.016>.
- Liu, Wen, Mohammad Ismail, Matthew T. Dunstan, Wenting Hu, Zili Zhang, Paul S. Fennell, Stuart A. Scott, and J. S. Dennis. 2015. "Inhibiting the Interaction between FeO and Al₂O₃ during Chemical Looping Production of Hydrogen." *RSC Adv.* 5 (3): 1759–71. <https://doi.org/10.1039/C4RA11891J>.
- Purdue, Mark J. 2018. "Explicit Flue Gas Adsorption Isotherm Model for Zeolite 13X Incorporating Enhancement of Nitrogen Loading by Adsorbed Carbon Dioxide and Multi-Site Affinity Shielding of Coadsorbate Dependent upon Water Vapor Content." *The Journal of Physical Chemistry C* 122 (22): 11832–11847. <https://doi.org/10.1021/acsc.jpcc.8b02071>.
- Purdue, Mark J., and Zhiwei Qiao. 2018. "Molecular Simulation Study of Wet Flue Gas

- Adsorption on Zeolite 13X." *Microporous and Mesoporous Materials* 261 (May): 181–97. <https://doi.org/10.1016/j.micromeso.2017.10.059>.
- Qin, Runze, and Hua Chun Zeng. 2018. "Design and Synthesis of Supported Nanoscale MOFs: Transformation from Transition Metal Silicates." *ACS Sustainable Chemistry & Engineering*, September. <https://doi.org/10.1021/acssuschemeng.8b03468>.
 - Sheng, Yuan, and Hua Chun Zeng. 2015a. "Structured Assemblages of Single-Walled 3d Transition Metal Silicate Nanotubes as Precursors for Composition-Tailorable Catalysts." *Chemistry of Materials* 27 (3): 658–67. <https://doi.org/10.1021/cm502691s>.
 - Sheng, Yuan, and Hua Chun Zeng. 2015b. "Monodisperse Aluminosilicate Spheres with Tunable Al/Si Ratio and Hierarchical Macro-Meso-Microporous Structure." *ACS Applied Materials & Interfaces* 7 (24): 13578–89. <https://doi.org/10.1021/acsami.5b03011>.
 - Sun, Bo, Tingjun Fu, and Hua Chun Zeng. 2018. "Controllable Integration of Ultrasmall Noble Metal Nanoparticles into Mesoporous Silica Matrixes by a Self-Assembly Method." *Chemical Communications* 54: 7030–33. <https://doi.org/10.1039/C8CC03236J>.
 - Tan, Ying Chuan, and Hua Chun Zeng. 2016. "Self-Templating Synthesis of Hollow Spheres of MOFs and Their Derived Nanostructures." *Chemical Communications* 52 (77): 11591–94. <https://doi.org/10.1039/C6CC05699G>.
 - Tan, Ying Chuan, and Hua Chun Zeng. 2017. "Defect Creation in HKUST-1 via Molecular Imprinting: Attaining Anionic Framework Property and Mesoporosity for Cation Exchange Applications." *Advanced Functional Materials* 27 (42): 1703765–73. <https://doi.org/DOI:10.1002/adfm.201703765>.
 - Tan, Ying Chuan, and Hua Chun Zeng. 2018. "Lewis Basicity Generated by Localised Charge Imbalance in Noble Metal Nanoparticle-Embedded Defective Metal–Organic Frameworks." *Nature Communications* 9 (1). <https://doi.org/10.1038/s41467-018-06828-4>.
 - Trinh, Quang Thang, Kartavya Bholra, Prince Nana Amaniampong, François Jérôme, and Samir H. Mushrif. 2018. "Synergistic Application of XPS and DFT to Investigate Metal Oxide Surface Catalysis." *The Journal of Physical Chemistry C* 122 (39): 22397–406. <https://doi.org/10.1021/acs.jpcc.8b05499>.
 - Trinh, Quang Thang, Hajime Hirao, John Mondal, Ramana Singuru, Biplab Banerjee, Benjaram M. Reddy, Asim Bhaumik, and Bolla G. Rao. 2016. "Integrated Experimental and Theoretical Study of Shape-Controlled Catalytic Oxidative Coupling of Aromatic Amines over CuO Nanostructures." *ACS Omega* 1 (6): 1121–1138. <https://doi.org/10.1021/acsomega.6b00331>.
 - Varghese, Jithin J., and Samir H. Mushrif. 2017. "Insights into the C-H Bond Activation on NiO Surfaces: The Role of Nickel and Oxygen Vacancies of Low Valent Dopants on the Reactivity and Energetics." *Journal of Physical Chemistry C* 121 (33): 17969–17981. <https://doi.org/DOI:10.1021/acs.jpcc.7b05226>.
 - Wang, Jingjing, and Hua Chun Zeng. 2018a. "CoHPi Nanoflakes for Enhanced Oxygen Evolution Reaction." *ACS Applied Materials and Interfaces* 10 (7): 6288–98. <https://doi.org/10.1021/acsami.7b17257>.
 - Wang, Jingjing, and Hua Chun Zeng. 2018b. "3D Hierarchical Multimetal-LDH Nanoflakes and Their Derived Spinel Oxides for Efficient Oxygen Evolution." *ACS Applied Energy Materials*, August. <https://doi.org/10.1021/acsaem.8b00990>.
 - Xi, Baojuan, Ying Chuan Tan, and Hua Chun Zeng. 2015. "A General Synthetic Approach for Integrated Nanocatalysts of Metal-Silica@ZIFs." *Chemistry of Materials* 28 (1): 326–336. <https://doi.org/10.1021/acs.chemmater.5b04147>.
 - Yan, Yibo, Yihu Dai, Shuchao Wang, Xinli Jia, Hao Yu, and Yanhui Yang. 2016. "Catalytic Applications of Alkali-Functionalized Carbon Nanospheres and Their Supported Pd Nanoparticles." *Applied Catalysis B: Environmental* 184 (March): 104–18. <https://doi.org/10.1016/j.apcatb.2015.11.024>.
 - Yan, Yibo, Kaixin Li, Yihu Dai, Xiaoping Chen, Jun Zhao, Yong Yan, Jijiang Huang, Yanhui Yang, and Jong-Min Lee. 2016. "Controlled Synthesis of 3D Nanoplate-Assembled La₂O₃ Hierarchical Microspheres for Enzyme-Free Detection of Hydrogen Peroxide." *ADVANCED MATERIALS INTERFACES* 3 (14). <https://doi.org/10.1002/admi.201500833>.
 - Yan, Yibo, Kaixin Li, Yihu Dai, Xiaoping Chen, Jun Zhao, Yanhui Yang, and Jong-Min Lee. 2016.

"Synthesis of 3D Mesoporous Samarium Oxide Hydrangea Microspheres for Enzyme-Free Sensor of Hydrogen Peroxide." *ELECTROCHIMICA ACTA* 208 (August): 231–37. <https://doi.org/10.1016/j.electacta.2016.05.037>.

- Yan, Yibo, Jianwei Miao, Zhihong Yang, Fang-Xing Xiao, Hong Bin Yang, Bin Liu, and Yanhui Yang. 2015. "Carbon Nanotube Catalysts: Recent Advances in Synthesis, Characterization and Applications." *Chem. Soc. Rev.* 44 (10): 3295–3346. <https://doi.org/10.1039/C4CS00492B>.
- Yan, Yong, Yihu Dai, Hong He, Yunbo Yu, and Yanhui Yang. 2016. "A Novel W-Doped Ni-Mg Mixed Oxide Catalyst for CO₂ Methanation." *Applied Catalysis B: Environmental* 196: 108–16. <https://doi.org/10.1016/j.apcatb.2016.05.016>.
- Yan, Yong, Yihu Dai, Yanhui Yang, and Alexei Lapkin. 2018. "Improved Stability of Y₂O₃ Supported Ni Catalysts for CO₂ Methanation by Precursor-Determined Metal-Support Interaction." *Applied Catalysis B: Environmental* 237 (December): 504–12. <https://doi.org/10.1016/j.apcatb.2018.06.021>.
- Yan, Yong, Qiaojuan Wang, Chunyang Jiang, Yao Yao, Di Lu, Jianwei Zheng, Yihu Dai, Hongming Wang, and Yanhui Yang. 2018. "Ru/Al₂O₃ Catalyzed CO₂ Hydrogenation: Oxygen-Exchange on Metal-Support Interfaces." *Journal of Catalysis* 367 (November): 194–205. <https://doi.org/10.1016/j.jcat.2018.08.026>.
- Yang, Shiliang, Andy Cahyadi, Yuhao Sun, Jingwei Wang, and Jia Wei Chew. 2016. "CFD-DEM Investigation into the Scaling up of Spout-Fluid Beds via Two Interconnected Chambers." *AIChE Journal* 62 (6): 1898–1916. <https://doi.org/10.1002/aic.15188>.
- Yang, Shiliang, Yuhao Sun, Jingwei Wang, Andy Cahyadi, and Jia Wei Chew. 2015. "Influence of Operating Parameters and Flow Regime on Solid Dispersion Behavior in a Gas-Solid Spout-Fluid Bed." *Chemical Engineering Science* 142: 112–25. <http://dx.doi.org/10.1016/j.ces.2015.11.038>.
- Yang, Shiliang, Yuhao Sun, Liangqi Zhang, and Jia Wei Chew. 2016. "Computational Study of the Effect of Draft Plates on the Solid Behavior in a Spout-Fluid Bed." *Industrial & Engineering Chemistry Research* 49 (55): 12598–615. <https://doi.org/10.1021/acs.iecr.6b02732>.
- Yang, Shiliang, Yuhao Sun, Liangqi Zhang, and Jia Wei Chew. 2017. "Improving the Operational Stability of the Multi-Chamber Spout-Fluid Bed via the Insertion of a Submerged Partition Plate." *AIChE Journal* 63 (2): 485–500. <https://doi.org/10.1002/aic.15427>.
- Yang, Shiliang, Yuhao Sun, Liangqi Zhang, Ya Zhao, and Jia Wei Chew. 2016. "Numerical Investigation on the Effect of Draft Plates on Spouting Stability and Gas-Solid Characteristics in a Spout-Fluid Bed." *Chemical Engineering Science*, March. <https://doi.org/10.1016/j.ces.2016.03.010>.
- Yang, Shiliang, Jingwei Wang, Andy Cahyadi, and Jia Wei Chew. 2016. "DEM Study of Granular Flow Characteristics in the Active and Passive Regions of a Three-Dimensional Rotating Drum." *AIChE Journal* 62 (11): 3874–88. <http://dx.doi.org/10.1002/aic.15315>.
- Yang, Shiliang, Ke Zhang, and Jia Wei Chew. 2015. "Computational Study of Spout Collapse and Impact of Partition Plate in a Double Slot-Rectangular Spouted Bed." *AIChE Journal* 61 (12): 4087–4101. <https://doi.org/10.1002/aic.14973>.
- Zhan, Guo Wu, and Hua Chun Zeng. 2016. "An Alternative Synthetic Approach for Macro-Meso-Microporous Metal-Organic Framework via 'Domain Growth' Mechanism." *Chem. Commun.* 52: 8432–35. <https://doi.org/10.1039/C6CC03555H>.
- Zhan, Guo Wu, and Hua Chun Zeng. 2017. "Smart Nanocatalysts with Streamline Shapes." *ACS Central Science* 3 (7): 794–99. <https://doi.org/10.1021/acscentsci.7b00216>.
- Zhan, Guowu, Ping Li, and Hua Chun Zeng. 2018. "Architectural Designs and Synthetic Strategies of Advanced Nanocatalysts." *Advanced Materials*, August, 1802094. <https://doi.org/10.1002/adma.201802094>.
- Zhan, Guowu, Christopher C. Yec, and Hua Chun Zeng. 2015. "Mesoporous Bubble-like Manganese Silicate as a Versatile Platform for Design and Synthesis of Nanostructured Catalysts." *Chemistry - A European Journal* 21 (5): 1882–87. <https://doi.org/10.1002/chem.201405697>.
- Zhan, Guowu, and Hua Chun Zeng. 2016a. "Charge-Switchable Integrated Nanocatalysts for Substrate-Selective Degradation in Advanced Oxidation Processes." *Chemistry of Materials* 28: 4572–82. <https://doi.org/10.1021/acs.chemmater.6b01128>.

- Zhan, Guowu, and Hua Chun Zeng. 2016b. "Synthesis and Functionalization of Oriented Metal-Organic Framework Nanosheets: Toward a Series of Two-Dimensional Catalysts." *Advanced Functional Materials* 26 (19): 3268–3281. <https://doi.org/10.1002/adfm.201505380>.
- Zhan, Guowu, and Hua Chun Zeng. 2016c. "Alternative Synthetic Approaches for Metal-Organic Frameworks: Transformation from Solid Matters." *Chemical Communications* 53 (1): 72–81. <https://doi.org/10.1039/C6CC07094A>.
- Zhan, Guowu, and Hua Chun Zeng. 2017a. "A Synthetic Protocol for Preparation of Binary Multi-Shelled Hollow Spheres and Their Enhanced Oxidation Application." *Chem. Mater.* 29 (23): 10104–10112. <https://doi.org/10.1021/acs.chemmater.7b03875>.
- Zhan, Guowu, and Hua Chun Zeng. 2017b. "Topological Transformations of Core-Shell Precursors to Hierarchically Hollow Assemblages of Copper Silicate Nanotubes." *ACS Appl. Mater. Interfaces* 9 (42): 37210–37218. <https://doi.org/10.1021/acsami.7b11808>.
- Zhan, Guowu, and Hua Chun Zeng. 2017c. "ZIF-67-Derived Nanoreactors for Controlling Product Selectivity in CO₂ Hydrogenation." *ACS Catal.* 7 (11): 7509–7519. <https://doi.org/10.1021/acscatal.7b01827>.
- Zhan, Guowu, and Hua Chun Zeng. 2018. "Hydrogen Spillover through Matryoshka-Type (ZIFs@)n-1ZIFs Nanocubes." *Nature Communications* 9 (September): 3778. <https://doi.org/10.1038/s41467-018-06269-z>.
- Zhan, Guowu, and Huachun Zeng. 2016d. "Integrated Nanocatalysts with Mesoporous Silica/Silicate and Microporous MOF Materials." *Coordination Chemistry Reviews* 320–321: 181–92. <https://doi.org/10.1016/j.ccr.2016.03.003>.
- Zhang, Liangqi, Shiliang Yang, Zhong Zeng, Jie Chen, Linmao Yin, and Jia Wei Chew. 2017. "Forcing Scheme Analysis for the Axisymmetric Lattice Boltzmann Method under Incompressible Limit." *PHYSICAL REVIEW E* 95: 043311. <https://doi.org/10.1103/PhysRevE.95.043311>.
- Zhang, Liangqi, Shiliang Yang, Zhong Zeng, Liping Yao, and Jia Wei Chew. 2016. "Alternative Kinetic Theory Based Lattice Boltzmann Model for Incompressible Axisymmetric Flows." *Computers and Mathematics with Applications* 72 (11): 2751–2772. <https://doi.org/10.1016/j.camwa.2016.09.028>.
- Zhang, Liangqi, Shiliang Yang, Zhong Zeng, Linmao Yin, Ya Zhao, and Jia Wei Chew. 2016. "Consistent Lattice Boltzmann Methods for Incompressible Axisymmetric flows." *PHYSICAL REVIEW E* 94 (August): 023302. <https://doi.org/10.1103/PhysRevE.94.023302>.
- Zhao, Jun, Chunmei Zhou, Chao He, Yihu Dai, Xinli Jia, and Yanhui Yang. 2015. "Efficient Dehydration of Fructose to 5-Hydroxymethylfurfural over Sulfonated Carbon Sphere Solid Acid Catalysts." *Catalysis Today*, August. <https://doi.org/10.1016/j.cattod.2015.07.005>.
- Zhao, Ya, Shiliang Yang, Liangqi Zhang, and Jia Wei Chew. 2018. "DEM Study on the Discharge Characteristics of Lognormal Particle Size Distributions from a Conical Hopper." *AIChE Journal* 64 (4): 1174–90. <https://doi.org/10.1002/aic.16026>.
- Zhou, Chunmei, Zhen Guo, Yihu Dai, Xinli Jia, Hao Yu, and Yanhui Yang. 2016. "Promoting Role of Bismuth on Carbon Nanotube Supported Platinum Catalysts in Aqueous Phase Aerobic Oxidation of Benzyl Alcohol." *Applied Catalysis B: Environmental* 181 (February): 118–26. <https://doi.org/10.1016/j.apcatb.2015.07.048>.
- Zhou, Yao, and Hua Chun Zeng. 2015. "Kinetically Controlled Growth of Fine Gold Nanofractals from Au(I) via Indirect Galvanic Replacement Reaction." *ACS Applied Materials & Interfaces* 7 (38): 21552–21561. <https://doi.org/10.1021/acsami.5b06818>.
- Zhou, Yao, and Hua Chun Zeng. 2016a. "Metal-Hydroxide and Au-Nanocluster Interfaces: Enhancing Catalyst Activity and Stability for Oxygen Evolution Reaction." *J. Phys. Chem. C* 120 (51): 29348–29357. <https://doi.org/10.1021/acs.jpcc.6b11102>.
- Zhou, Yao, and Hua Chun Zeng. 2016b. "Alumina-Supported Metal Catalysts inside a Mesoporous Aluminum-Silicate Shell: Nanoscale Reactors Prepared through Transformation of MIL-96(Al) Nanocrystals." *ChemCatChem* 8 (7): 1283–1287. <https://doi.org/10.1002/cctc.201600062>.
- Zhou, Yao, and Hua Chun Zeng. 2016c. "Transition Ions Induced Coalescence: Stitching Au Nanoclusters into Tubular Au-Based Nanocomposites." *Small* 12 (19): 2652–2664. <https://doi.org/10.1002/smll.201503881>.

- Zhou, Yao, and Hua Chun Zeng. 2017. "Synthesis, Self-Assembly, Transformation, and Functionalization of Nanoscale Artificial Allophane Spherules for Catalytic Applications." *Chemistry of Materials* 29 (14): 6076–86. <https://doi.org/10.1021/acs.chemmater.7b01956>.
- Zhou, Yao, and Hua Chun Zeng. 2018. "3D Networks of CoFePi with Hierarchical Porosity for Effective OER Electrocatalysis." *Small* 14 (21): 1704403. <https://doi.org/10.1002/sml.201704403>.

C4T IRP2 — EMSET

- Ahn, Sunyihik D., Paul E. Frith, Adrian C. Fisher, Alan M. Bond, and Frank Marken. 2014. "Mass Transport and Modulation Effects in Rocking Dual-Semi-Disc Electrode Voltammetry." *Journal of Electroanalytical Chemistry* 722–723 (May): 78–82. <https://doi.org/10.1016/j.jelechem.2014.02.018>.
- Ahn, Sunyihik D., Karthik Somasundaram, H. Viet Nguyen, Erik Birgersson, Jim Yang Lee, Xiangming Gao, Adrian C. Fisher, Paul E. Frith, and Frank Marken. 2015. "Hydrodynamic Voltammetry at a Rocking Disc Electrode: Theory versus Experiment." *Electrochimica Acta* 188: 837–44. <https://doi.org/10.1016/j.electacta.2015.11.143>.
- Cao, Sheng, Shengliang Zhang, Tianran Zhang, Adrian Fisher, and Jim Yang Lee. 2018. "Metal-Doped TiO₂ Colloidal Nanocrystals with Broadly Tunable Plasmon Resonance Absorption." *Journal of Materials Chemistry C* 6 (15): 4007–14. <https://doi.org/10.1039/C8TC00185E>.
- Cao, Sheng, Shengliang Zhang, Tianran Zhang, and Jim Yang Lee. 2018. "Fluoride-Assisted Synthesis of Plasmonic Colloidal Ta-Doped TiO₂ Nanocrystals for Near-Infrared and Visible-Light Selective Electrochromic Modulation." *Chemistry of Materials* 30 (14): 4838–46. <https://doi.org/10.1021/acs.chemmater.8b02196>.
- Chen, Rong, Gengzhi Sun, Cangjie Yang, Liping Zhang, Jianwei Miao, Huabing Tao, Hongbin Yang, Jiazang Chen, Peng Chen, and Bin Liu. 2016. "Achieving Stable and Efficient Water Oxidation by Incorporating NiFe Layered Double Hydroxide Nanoparticles into Aligned Carbon Nanotubes." *Nanoscale Horiz.* 1 (2): 156–60. <https://doi.org/10.1039/C5NH00082C>.
- Chen, Rong, Hsin-Yi Wang, Jianwei Miao, Hongbin Yang, and Bin Liu. 2015. "A Flexible High-Performance Oxygen Evolution Electrode with Three-Dimensional NiCo₂O₄ Core-Shell Nanowires." *Nano Energy* 11 (January): 333–40. <https://doi.org/10.1016/j.nanoen.2014.11.021>.
- Dai, Chencheng, Chun-Wai I. Chan, William Barrow, Anna Smith, Peng Song, Francois Potier, Jay D. Wadhawan, Adrian C. Fisher, and Nathan S. Lawrence. 2016. "A Route to Unbuffered PH Monitoring: A Novel Electrochemical Approach." *Electrochimica Acta* 190 (February): 879–86. <https://doi.org/10.1016/j.electacta.2016.01.004>.
- Dai, Chencheng, Lynne P. Crawford, Peng Song, Adrian C. Fisher, and Nathan S. Lawrence. 2015. "A Novel Sensor Based on Electropolymerized Substituted-Phenols for PH Detection in Unbuffered Systems." *RSC Advances* 2015 (126): 104048–53. <https://doi.org/10.1039/c5ra22595g>.
- Dai, Chencheng, Peng Song, Jay D. Wadhawan, Adrian C. Fisher, and Nathan S. Lawrence. 2015. "Screen Printed Alizarin-Based Carbon Electrodes: Monitoring PH in Unbuffered Media." *Electroanalysis* 27 (4): 917–23. <https://doi.org/10.1002/elan.201400704>.
- Dai, Chencheng, Libo Sun, Hanbin Liao, Bahareh Khezri, Richard D. Webster, Adrian C. Fisher, and Zhichuan J. Xu. 2017. "Electrochemical Production of Lactic Acid from Glycerol Oxidation Catalyzed by AuPt Nanoparticles." *Journal of Catalysis* Volume 356 (December 2017): Pages 14–21. <https://doi.org/10.1016/j.jcat.2017.10.010>.
- Elouarzaki, Kamal, Daojian Cheng, Adrian C. Fisher, and Jong-Min Lee. 2018. "Coupling Orientation and Mediation Strategies for Efficient Electron Transfer in Hybrid Biofuel Cells." *Nature Energy* 3 (7): 574–81. <https://doi.org/10.1038/s41560-018-0166-4>.
- Elouarzaki, Kamal, Adrian C. Fisher, and Jong-Min Lee. 2017. "Molecular Porphyrinic Freestanding Buckypaper Electrodes from Carbon Nanotubes for Glucose Fuel Cells." *Journal of Materials Chemistry A* 5 (19): 8927–32. <https://doi.org/10.1039/C7TA01525A>.
- Gu, Yunfeng, and Adrian C. Fisher. 2013. "An Ac Voltammetry Approach for the Detection of Droplets in Microfluidic Devices." *The Analyst* 138 (16): 4448. <https://doi.org/10.1039/c3an00822c>.
- Gusmão, Rui, Zdenek Sofer, and Martin Pumera. 2017. "Black Phosphorus Rediscovered: From

Bulk to Monolayer." *Angew. Chemie Int. Ed.* 2017, January. <https://doi.org/10.1002/anie.201610512>.

- Hu, Hanjun, Yutian Wang, Nian Du, Yufan Sun, Yang Tang, Qing Hu, Pingyu Wan, Liming Dai, Adrian C. Fisher, and Xiao Jin Yang. 2018. "Thermal Treatment Induced Cu-Sn Core/Shell Nanowire Array Catalysts for Highly Efficient CO₂ Electroreduction." *ChemElectroChem*, October. <https://doi.org/10.1002/celec.201801267>.
- Hu, Nantao, Liling Zhang, Chao Yang, Jian Zhao, Zhi Yang, Hao Wei, Hanbin Liao, et al. 2016. "Three-Dimensional Skeleton Networks of Graphene Wrapped Polyaniline Nanofibers: An Excellent Structure for High-Performance Flexible Solid-State Supercapacitors." *Scientific Reports* 6 (January): 19777. <https://doi.org/10.1038/srep19777>.
- Huang, Bicheng, Hongyuan Shao, Naiqiang Liu, Zhichuan J. Xu, and Yaqin Huang. 2015. "From Fish Scales to Highly Porous N-Doped Carbon: A Low Cost Material Solution for CO₂ Capture." *RSC Adv.* 5 (107): 88171–75. <https://doi.org/10.1039/C5RA16745K>.
- Inglesby, Alister E., and Adrian C. Fisher. 2013. "Downstream Application of a Microbial Fuel Cell for Energy Recovery from an *Arthrospira Maxima* Fed Anaerobic Digester Effluent." *RSC Advances* 3 (38): 17387. <https://doi.org/10.1039/c3ra42277a>.
- Jiang, Yuanyuan, Pengjuan Ni, Chuanxia Chen, Yizhong Lu, Ping Yang, Biao Kong, Adrian Fisher, and Xin Wang. 2018. "Selective Electrochemical H₂O₂ Production through Two-Electron Oxygen Electrochemistry." *Advanced Energy Materials*, September, 1801909. <https://doi.org/10.1002/aenm.201801909>.
- Jiong, Wang, Zhang Hua, and Wang Xin. 2017. "Recent Methods for the Synthesis of Noble-Metal-Free Hydrogen-Evolution Electrocatalysts: From Nanoscale to Sub-Nanoscale." *Small Methods*, May. <https://doi.org/10.1002/smt.201700118>.
- Jose, Vishal, Kamal Elouarzaki, Adrian C. Fisher, and Jong-Min Lee. 2018. "Design and Integration of Molecular-Type Catalysts in Fuel-Cell Technology." *Small Methods* 2 (10): 1800059. <https://doi.org/10.1002/smt.201800059>.
- Khezri, B., Y. Y. Chan, L. Y. D. Tiong, and Richard D. Webster. 2015. "Annual Air Pollution Caused by the Hungry Ghost Festival." *Environ. Sci.: Processes Impacts*. <https://doi.org/10.1039/C5EM00312A>.
- Khezri, Bahareh, Adrian C. Fisher, and Martin Pumera. 2017. "CO₂ Reduction: The Quest for Electrocatalytic Materials." *Journal of Materials Chemistry A.*, May, 8230–46. <https://doi.org/10.1039/C6TA09875D>.
- Latiff, Naziah M., Carmen C. Mayorga-Martinez, Lu Wang, Zdenek Sofer, Adrian C. Fisher, and Martin Pumera. 2017. "Microwave Irradiated N- and B,Cl-Doped Graphene: Oxidation Method Has Strong Influence on Capacitive Behavior." *2017* 9: 204–211. <http://dx.doi.org/10.1016/j.apmt.2017.07.006>.
- Latiff, Naziah M., Zdenek Sofer, Adrian C. Fisher, and Martin Pumera. 2016. "Cytotoxicity of Exfoliated Layered Vanadium Dichalcogenides." *Chemistry - A European Journal* 23 (3): 684–90. <https://doi.org/10.1002/chem.201604430>.
- Latiff, Naziah M., Lu Wang, Carmen C. Mayorga-Martinez, Zdeněk Sofer, Adrian C. Fisher, and Martin Pumera. 2016. "Valence and Oxide Impurities in MoS₂ and WS₂ Dramatically Change Their Electrocatalytic Activity towards Proton Reduction." *Nanoscale* 8: 16752–60. <https://doi.org/10.1039/c6nr03086f>.
- Latiff, Naziah Mohamad, Wei Zhe Teo, Zdenek Sofer, Adrian C. Fisher, and Martin Pumera. 2015. "The Cytotoxicity of Layered Black Phosphorus." *Chemistry - A European Journal* 21 (40): 13991–95. <https://doi.org/10.1002/chem.201502006>.
- Latiff, Naziah, Wei Zhe Teo, Zdenek Sofer, Štěpán Huber, Adrian C. Fisher, and Martin Pumera. 2015. "Toxicity of Layered Semiconductor Chalcogenides: Beware of Interferences." *RSC Adv.* 5 (83): 67485–92. <https://doi.org/10.1039/C5RA09404F>.
- Lee, Jazreen H.Q., Sherman J.L. Lauw, and Richard D. Webster. 2016. "The Electrochemical Reduction of Carbon Dioxide (CO₂) to Methanol in the Presence of Pyridoxine (Vitamin B6)." *Electrochemistry Communications* 64 (March): 69–73. <https://doi.org/10.1016/j.elecom.2016.01.016>.
- Li, Haiyan, Yubo Chen, Shibo Xi, Jingxian Wang, Shengnan Sun, Yuanmiao Sun, Yonghua Du, and Zhichuan J. Xu. 2018. "Degree of Geometric Tilting Determines the Activity of FeO₆ Octahe-

- dra for Water Oxidation." *Chemistry of Materials* 30 (13): 4313–20. <https://doi.org/10.1021/acs.chemmater.8b01321>.
- Li, Haiyan, Shengnan Sun, Shibo Xi, YuBo Chen, Ting Wang, Yonghua Du, Matthew Sherburne, Joel W. Ager, Adrian C. Fisher, and Zhichuan J. Xu. 2018. "Metal-Oxygen Hybridization Determined Activity in Spinel-Based Oxygen Evolution Catalysts: A Case Study of $ZnFe_{2-x}Cr_xO_4$." *Chemistry of Materials* 30 (19): 6839–48. <https://doi.org/10.1021/acs.chemmater.8b02871>.
 - Li, Nan, Larissa Thia, and Xin Wang. 2014. "A CO₂-Responsive Surface with an Amidine-Terminated Self-Assembled Monolayer for Stimuli-Induced Selective Adsorption." *Chemical Communications* 50 (30): 4003. <https://doi.org/10.1039/c4cc00412d>.
 - Li, Nan, Hai-Bo Wang, Larissa Thia, Jing-Yuan Wang, and Xin Wang. 2015. "Enzymatic-Reaction Induced Production of Polydopamine Nanoparticles for Sensitive and Visual Sensing of Urea." *The Analyst* 140 (2): 449–55. <https://doi.org/10.1039/C4AN01900H>.
 - Li, Nan, Ya Yan, Bao-Yu Xia, Jing-Yuan Wang, and Xin Wang. 2014. "Novel Tungsten Carbide Nanorods: An Intrinsic Peroxidase Mimetic with High Activity and Stability in Aqueous and Organic Solvents." *Biosensors and Bioelectronics* 54 (April): 521–27. <https://doi.org/10.1016/j.bios.2013.11.040>.
 - Liao, Hanbin, Adrian C. Fisher, and Zhichuan J. Xu. 2015. "Surface Segregation in Bimetallic Nanoparticles: A Critical Issue in Electrocatalyst Engineering." *Small* 11 (27): 3221–46. <https://doi.org/10.1002/sml.201403380>.
 - Liao, Hanbin, Yuanmiao Sun, Chencheng Dai, Yonghua Du, Shibo Xi, Fei Liu, Linghui Yu, et al. 2018. "An Electron Deficiency Strategy for Enhancing Hydrogen Evolution on CoP Nano-Electrocatalysts." *Nano Energy* 50 (August): 273–80. <https://doi.org/10.1016/j.nanoen.2018.05.060>.
 - Liao, Hanbin, Chao Wei, Jingxian Wang, Adrian C. Fisher, Thirumany Sritharan, Zhenxing Feng, and Zhichuan J. Xu. 2017. "A Multisite Strategy for Enhancing the Hydrogen Evolution Reaction on a Nano-Pd Surface in Alkaline Media." *Advanced Energy Materials*, August. <https://doi.org/10.1002/aenm.201701129>.
 - Lim, Rern Jern, Mingshi Xie, Mahasin Alam Sk, Jong-Min Lee, Adrian C. Fisher, Xin Wang, and Kok Hwa Lim. 2014. "A Review on the Electrochemical Reduction of CO₂ in Fuel Cells, Metal Electrodes and Molecular Catalysts." *Catalysis Today* 233 (September): 169–80. <https://doi.org/10.1016/j.cattod.2013.11.037>.
 - Liu, Ying, Hanbin Liao, Ye Zhou, Yonghua Du, Chao Wei, Jian Zhao, Shengnan Sun, Joachim S. C. Loo, and Zhichuan J. Xu. 2015. "Fe₂O₃ Nanoparticle/SWCNT Composite Electrode for Sensitive Electrocatalytic Oxidation of Hydroquinone." *Electrochimica Acta* 180: 1059–67. <https://doi.org/10.1016/j.electacta.2015.09.046>.
 - Ng, Fong-Lee, Muhammad Musoddiq Jaafar, Siew-Moi Phang, Zhijian Chan, Nurul Anati Salleh, Siti Zulfikriyah Azmi, Kamran Yunus, Adrian C. Fisher, and Vengadesh Periasamy. 2014. "Reduced Graphene Oxide Anodes for Potential Application in Algae Biophotovoltaic Platforms." *Scientific Reports* 4 (December): 7562. <https://doi.org/10.1038/srep07562>.
 - Ng, Fong-Lee, Siew-Moi Phang, Vengadesh Periasamy, Kamran Yunus, and Adrian C. Fisher. 2014. "Evaluation of Algal Biofilms on Indium Tin Oxide (ITO) for Use in Biophotovoltaic Platforms Based on Photosynthetic Performance." Edited by Nikolai Lebedev. *PLoS ONE* 9 (5): e97643. <https://doi.org/10.1371/journal.pone.0097643>.
 - Periasamy, Vengadesh, G. P. M. K. Ciniciato, C. Zhijian, Muhammad Musoddiq, Adrian C. Fisher, and Kamran Yunus. 2015. "Capillary Force Assisted Fabrication of DNA Templated Silver Wires." *RSC Adv.* 5 (11): 8163–66. <https://doi.org/10.1039/C4RA16448B>.
 - Rosli, Nur Farhanah, Carmen C. Mayorga-Martinez, Naziah M. Latiff, Nasuha Rohaizad, Zdeněk Sofer, Adrian C. Fisher, and Martin Pumera. 2018. "Layered PtTe₂ Matches Electrocatalytic Performance of Pt/C for Oxygen Reduction Reaction with Significantly Lower Toxicity." *ACS Sustainable Chemistry & Engineering* 6 (6): 7432–41. <https://doi.org/10.1021/acssuschemeng.7b04920>.
 - Song, Peng, Adrian C. Fisher, Jay D. Wadhawan, Joshua J. Cooper, Haydn J. Ward, and Nathan S. Lawrence. 2016. "A Mechanistic Study of the EC' Mechanism – the Split Wave in Cyclic Voltammetry and Square Wave Voltammetry." *RSC Advances* 2016 (6): 70237–42. <https://doi.org/10.1039/c6ra08723j>.

- Sun, Shengnan, Haiyan Li, and Zhichuan J. Xu. 2018. "Impact of Surface Area in Evaluation of Catalyst Activity." *Joule* 2 (6): 1024–27. <https://doi.org/10.1016/j.joule.2018.05.003>.
- Sun, Shengnan, Libo Sun, Shibo Xi, Yonghua Du, M. U. Anu Prathap, Zilong Wang, Qichun Zhang, Adrian C. Fisher, and Zhichuan J. Xu. 2017. "Electrochemical Oxidation of C3 Saturated Alcohols on Co₃O₄ in Alkaline." *Electronica Acta* 228 (February): 1830194. <http://dx.doi.org/10.1016/j.electacta.2017.01.086>.
- Sun, Shengnan, and Zhichuan J. Xu. 2015. "Composition Dependence of Methanol Oxidation Activity in Nickel–Cobalt Hydroxides and Oxides: An Optimization toward Highly Active Electrodes." *Electrochimica Acta* 165 (May): 56–66. <https://doi.org/10.1016/j.electacta.2015.03.008>.
- Sun, Shengnan, Ye Zhou, Benlin Hu, Qichun Zhang, and Zhichuan J. Xu. 2016. "Ethylene Glycol and Ethanol Oxidation on Spinel Ni-Co Oxides in Alkaline." *Journal of The Electrochemical Society* 163 (2): H99–104. <https://doi.org/10.1149/2.0761602jes>.
- Tao, Hua Bing, Liwen Fang, Jiazang Chen, Hong Yang Bin, Jiajian Gao, Jianwei Miao, Shengli Chen, and Bin Liu. 2016. "Identification of Surface Reactivity Descriptor for Transition Metal Oxides in Oxygen Evolution Reaction." *Journal of the American Chemical Society* 138 (31): 9978–9985. <https://doi.org/10.1021/jacs.6b05398>.
- Tessensohn, Malcolm E., Shu Jun Ng, Kwok Kiong Chang, Sher Li Gan, Natalie F. Sims, Yu Rong Koh, and Richard D. Webster. 2016. "Impurities in Nitrile Solvents Commonly Used for Electrochemistry, and Their Effects on Voltammetric Data." *ChemElectroChem* 3 (11): 1753–59. <https://doi.org/10.1002/celec.201600597>.
- Thia, Larissa, Mingshi Xie, Donghwan Kim, and Xin Wang. 2017. "Ag Containing Porous Au Structures as Highly Selective Catalysts for Glycolate and Formate." *Catalysis Science and Technology*, no. 4 (January): 874–81. <https://doi.org/10.1039/C6YO2580C>.
- Thia, Larissa, Mingshi Xie, Zhaolin Liu, Xiaoming Ge, Yizhong Lu, Wenmei Eileen Fong, and Xin Wang. 2016. "Copper-Modified Gold Nanoparticles as Highly Selective Catalysts for Glycerol Electro-Oxidation in Alkaline Solution." *Chemcatchem* 8 (20): 3272–78. <http://dx.doi.org/10.1002/cctc.201600725>.
- Urbančok, Dejan, Anthony J.R. Payne, and Richard D. Webster. 2017. "Regional Transport, Source Apportionment and Health Impact of PM10 Bound Polycyclic Aromatic Hydrocarbons in Singapore's Atmosphere." *Environmental Pollution* 229 (October): 984–93. <https://doi.org/10.1016/j.envpol.2017.07.086>.
- Wang, Haibo, Larissa Thia, Nan Li, Xiaoming Ge, Zhaolin Liu, and Xin Wang. 2015a. "Selective Electro-Oxidation of Glycerol over Au Supported on Extended Poly(4-Vinylpyridine) Functionalized Graphene." *Applied Catalysis B: Environmental* 166–167 (May): 25–31. <https://doi.org/10.1016/j.apcatb.2014.11.009>.
- Wang, Haibo, Larissa Thia, Nan Li, Xiaoming Ge, Zhaolin Liu, and Xin Wang. 2015b. "Pd Nanoparticles on Carbon Nitride–Graphene for the Selective Electro-Oxidation of Glycerol in Alkaline Solution." *ACS Catalysis* 5 (6): 3174–80. <https://doi.org/10.1021/acscatal.5b00183>.
- Wang, Haibo, Mingshi Xie, Larissa Thia, Adrian Fisher, and Xin Wang. 2014. "Strategies on the Design of Nitrogen-Doped Graphene." *The Journal of Physical Chemistry Letters* 5 (1): 119–25. <https://doi.org/10.1021/jz402416a>.
- Wang, Hsin-Yi, Ying-Ya Hsu, Rong Chen, Ting-Shan Chan, Hao Ming Chen, and Bin Liu. 2015. "Ni³⁺-Induced Formation of Active NiOOH on the Spinel Ni-Co Oxide Surface for Efficient Oxygen Evolution Reaction." *Advanced Energy Materials* 5 (10). <https://doi.org/10.1002/aenm.201500091>.
- Wang, Hsin-Yi, Sung-Fu Hung, Han-Yi Chen, Ting-Shan Chan, Hao Ming Chen, and Bin Liu. 2016. "In Operando Identification of Geometrical-Site-Dependent Water Oxidation Activity of Spinel Co₃O₄." *Journal of the American Chemical Society* 138 (1): 36–39. <https://doi.org/10.1021/jacs.5b10525>.
- Wang, Jiong, Liyong Gan, Wenyu Zhang, Yuecheng Peng, Hong Yu, Qingyu Yan, Xinghua Xia, and Xin Wang. 2018. "In Situ Formation of Molecular Ni-Fe Active Sites on Heteroatom-Doped Graphene as a Heterogeneous Electrocatalyst toward Oxygen Evolution." *Science Advances* 4 (3): eaap7970. <https://doi.org/10.1126/sciadv.aap7970>.
- Wang, Jiong, Xiaoming Ge, Zhaolin Liu, Larissa Thia, Wei Xiao, and Xin Wang. 2017.

- “Heterogeneous Electrocatalyst with Molecular Cobalt Ions Serving as the Center of Active Sites.” *Journal of the American Chemical Society* 139 (5): 1878–84. <https://doi.org/10.1021/jacs.6b10307>.
- Wang, Luyuan Paul, Linghui Yu, Rohit Satish, Jixin Zhu, Qingyu Yan, Madhavi Srinivasan, and Zhichuan Xu. 2014. “High-Performance Hybrid Electrochemical Capacitor with Binder-Free Nb₂O₅@graphene.” *RSC Advances* 4 (70): 37389. <https://doi.org/10.1039/C4RA06674J>.
 - Wang, Luyuan Paul, Linghui Yu, Xin Wang, Madhavi Srinivasan, and Zhichuan J. Xu. 2015. “Recent Developments in Electrode Materials for Sodium-Ion Batteries.” *J. Mater. Chem. A* 3 (18): 9353–78. <https://doi.org/10.1039/C4TA06467D>.
 - Wang, Luyuan Paul, Yi Zhao, Chao Wei, Chuiling Wong, Madhavi Srinivasan, and Zhichuan J. Xu. 2015. “Polycrystalline Zinc Stannate as an Anode Material for Sodium-Ion Batteries.” *J. Mater. Chem. A* 3 (26): 14033–38. <https://doi.org/10.1039/C5TA02734A>.
 - Wei, Chao, Zhenxing Feng, Günther G. Scherer, James Barber, Shao-Horn Yang, and Zhichuan J. Xu. 2017. “Cations in Octahedral Sites: A Descriptor for Oxygen Electrocatalysis on Transition-Metal Spinels.” *Advanced Materials* 29 (23): 1606800. <https://doi.org/doi.org/10.1002/adma.201606800>.
 - Wei, Chao, Pooi See Lee, and Zhichuan J. Xu. 2014. “A Comparison of Carbon Supports in MnO₂/C Supercapacitors.” *RSC Advances* 4 (59): 31416. <https://doi.org/10.1039/C4RA04914D>.
 - Xia, Bao Yu, Hao Bin Wu, Nan Li, Ya Yan, Xiong Wen David Lou, and Xin Wang. 2015. “One-Pot Synthesis of Pt-Co Alloy Nanowire Assemblies with Tunable Composition and Enhanced Electrocatalytic Properties.” *Angewandte Chemie International Edition* 54 (12): 3797–3801. <https://doi.org/10.1002/anie.201411544>.
 - Xiao, Fang-Xing, Mario Pagliaro, Yi-Jun Xu, and Bin Liu. 2016. “Layer-by-Layer Assembly of Versatile Nanoarchitectures with Diverse Dimensionality: A New Perspective for Rational Construction of Multilayer Assemblies.” *Chemical Society Reviews* 11 (45): 3088–3121. <https://doi.org/10.1039/C5CS00781J>.
 - Xiao, Peng, Xiaoming Ge, Haibo Wang, Zhaolin Liu, Adrian C. Fisher, and Xin Wang. 2015. “Novel Molybdenum Carbide-Tungsten Carbide Composite Nanowires and Their Electrochemical Activation for Efficient and Stable Hydrogen Evolution.” *Advanced Functional Materials* 25 (10): 1520–26. <https://doi.org/10.1002/adfm.201403633>.
 - Xiao, Peng, Mahasin Alam Sk, Larissa Thia, Xiaoming Ge, Rern Jern Lim, Jing-Yuan Wang, Kok Hwa Lim, and Xin Wang. 2014. “Molybdenum Phosphide as an Efficient Electrocatalyst for the Hydrogen Evolution Reaction.” *Energy Environ. Sci.* 7 (8): 2624–29. <https://doi.org/10.1039/C4EE00957F>.
 - Xie, Ming Shi, Bao Yu Xia, Yawei Li, Ya Yan, Yanhui Yang, Qiang Sun, Siew Hwa Chan, Adrian C. Fisher, and Xin Wang. 2016. “Amino Acid Modified Copper Electrodes for the Enhanced Selective Electroreduction of Carbon Dioxide towards Hydrocarbons.” *Energy Environ. Sci.*, no. 5: 1687–95. <https://doi.org/10.1039/C5EE03694A>.
 - Yan, Duan, Sun Shengnan, Xi Shibo, Ren Xiao, Zhou Ye, Zhang Ganlu, Yang Haitao, Du Yonghua, and Xu Zhichuan J. 2017. “Tailoring the Co 3d-O 2p Covalency in LaCoO₃ by Fe Substitution To Promote Oxygen Evolution Reaction.” *Chemistry of Materials* 29 (24): 10534–10541. <https://doi.org/10.1021/acs.chemmater.7b04534>.
 - Yan, Ya, Larissa Thia, Bao Yu Xia, Xiaoming Ge, Zhaolin Liu, Adrian C. Fisher, and Xin Wang. 2015. “Construction of Efficient 3D Gas Evolution Electrocatalyst for Hydrogen Evolution: Porous FeP Nanowire Arrays on Graphene Sheets.” *Advanced Science* 2 (8). <https://doi.org/10.1002/advs.201500120>.
 - Yan, Ya, Bao Yu Xia, Xiaoming Ge, Zhaolin Liu, Adrian C. Fisher, and Xin Wang. 2015. “A Flexible Electrode Based on Iron Phosphide Nanotubes for Overall Water Splitting.” *Chemistry - A European Journal* 21 (50): 18062–67. <https://doi.org/10.1002/chem.201503777>.
 - Yan, Ya, Bao Yu Xia, Xiaoming Ge, Zhaolin Liu, Jing-Yuan Wang, and Xin Wang. 2013. “Ultrathin MoS₂ Nanoplates with Rich Active Sites as Highly Efficient Catalyst for Hydrogen Evolution.” *ACS Applied Materials & Interfaces* 5 (24): 12794–98. <https://doi.org/10.1021/am404843b>.
 - Yan, Ya, Bao Yu Xia, Nan Li, Zhichuan J. Xu, Adrian Fisher, and Xin Wang. 2015. “Vertically Oriented MoS₂ and WS₂ Nanosheets Directly Grown on Carbon Cloth as Efficient and Stable 3-Dimensional Hydrogen-Evolving Cathodes.” *J. Mater. Chem. A* 3 (1): 131–35. <https://doi.org/10.1039/C4TA06467D>.

doi.org/10.1039/C4TA04858J.

- Yan, Ya, BaoYu Xia, Zhichuan J. Xu, and Xin Wang. 2014. "Recent Development of Molybdenum Sulfides as Advanced Electrocatalysts for Hydrogen Evolution Reaction." *ACS Catalysis* 4 (6): 1693–1705. <https://doi.org/10.1021/cs500070x>.
- Yan, Yibo, Jianwei Miao, Zhihong Yang, Fang-Xing Xiao, Hong Bin Yang, Bin Liu, and Yanhui Yang. 2015. "Carbon Nanotube Catalysts: Recent Advances in Synthesis, Characterization and Applications." *Chem. Soc. Rev.* 44 (10): 3295–3346. <https://doi.org/10.1039/C4CS00492B>.
- Yang, Hong Bin, Jianwei Miao, Sung-Fu Hung, Jiazang Chen, Hua Bing Tao, Xizu Wang, Liping Zhang, et al. 2016. "Identification of Catalytic Sites for Oxygen Reduction and Oxygen Evolution in N-Doped Graphene Materials: Development of Highly Efficient Metal-Free Bifunctional Electrocatalyst." *Science Advances* 2 (4,e1501122). [https://doi.org/DOI: 10.1126/sciadv.1501122](https://doi.org/DOI:10.1126/sciadv.1501122).
- Yu, Linghui, Luyuan Paul Wang, Shibo Xi, Ping Yang, Yonghua Du, Madhavi Srinivasan, and Zhichuan J. Xu. 2015. " β -FeOOH: An Earth-Abundant High-Capacity Negative Electrode Material for Sodium-Ion Batteries." *Chemistry of Materials* 27 (15): 5340–48. <https://doi.org/10.1021/acs.chemmater.5b01747>.
- Yu, Linghui, Chao Wei, Qingyu Yan, and Zhichuan J. Xu. 2015. "Controlled Synthesis of High-Performance β -FeOOH Anodes for Lithium-Ion Batteries and Their Size Effects." *Nano Energy* 13 (April): 397–404. <https://doi.org/10.1016/j.nanoen.2015.03.003>.
- Yu, Linghui, Shibo Xi, Chao Wei, Wenyu Zhang, Yonghua Du, Qingyu Yan, and Zhichuan J. Xu. 2015. "Superior Lithium Storage Properties of β -FeOOH." *Advanced Energy Materials* 5 (6). <https://doi.org/10.1002/aenm.201401517>.
- Zhang, Shengliang, Sheng Cao, Tianran Zhang, Adrian Fisher, and Jim Yang Lee. 2018. " Al^{3+} Intercalation/de-Intercalation-Enabled Dual-Band Electrochromic Smart Windows with a High Optical Modulation, Quick Response and Long Cycle Life." *Energy & Environmental Science* 11 (10): 2884–92. <https://doi.org/10.1039/C8EE01718B>.
- Zhang, Shengliang, Sheng Cao, Tianran Zhang, Qiaofeng Yao, Adrian C. Fisher, and Jim Yang Lee. 2018. "Monoclinic Oxygen-Deficient Tungsten Oxide Nanowires for Dynamic and Independent Control of near-Infrared and Visible Light Transmittance." *Materials Horizons* 5 (January): 291–97. <https://doi.org/10.1039/C7MH01128H>.
- Zhang, Tianran, Xiaoming Ge, Zhao Zhang, Nguk Neng Tham, Zhaolin Liu, Adrian C. Fisher, and Jim Yang Lee. 2017. "Improving the Electrochemical Oxygen Reduction Activity of Manganese Oxide Nanosheets with Sulfurization-Induced Nanopores." *ChemCatChem* 10 (2): 422–29. <https://doi.org/10.1002/cctc.201701192>.
- Zhang, Tianran, Nguk Neng Tham, Zhaolin Liu, Adrian Fisher, and Jim Yang Lee. 2018. "Promotion of the Bifunctional Electrocatalytic Oxygen Activity of Manganese Oxides with Dual-Affinity Phosphate." *Electrochimica Acta* 277 (July): 143–50. <https://doi.org/10.1016/j.electacta.2018.05.009>.
- Zhao, Yi, Zhenxing Feng, and Zhichuan J. Xu. 2015. "Yolk-Shell $\text{Fe}_2\text{O}_3 @ \text{C}$ Composites Anchored on MWNTs with Enhanced Lithium and Sodium Storage." *Nanoscale* 7 (21): 9520–25. <https://doi.org/10.1039/C5NR01281C>.
- Zhao, Yi, Luyuan Paul Wang, Sougrati Moulay Tahar, Zhenxing Feng, Yann Leconte, Adrian C. Fisher, Madhavi Srinivasan, and Zhichuan J. Xu. 2016. "A Review on Design Strategies for Carbon Based Metal Oxides and Sulfides Nanocomposites for High Performance Li and Na Ion Battery Anodes." *Advanced Energy Materials* 7 (9). <https://doi.org/10.1002/aenm.201601424>.
- Zhao, Yi, Chao Wei, Shengnan Sun, Luyuan Paul Wang, and Zhichuan J. Xu. 2015. "Reserving Interior Void Space for Volume Change Accommodation: An Example of Cable-Like MWNTs@ $\text{SnO}_2 @ \text{C}$ Composite for Superior Lithium and Sodium Storage." *Advanced Science* 2 (6): n/a-n/a. <https://doi.org/10.1002/advs.201500097>.
- Zhao, Yi, Wangliang Wu, Jiabin Li, Zhichuan J. Xu, and Lunhui Guan. 2014. "Encapsulating MWNTs into Hollow Porous Carbon Nanotubes: A Tube-in-Tube Carbon Nanostructure for High-Performance Lithium-Sulfur Batteries." *Advanced Materials* 26 (30): 5113–18. <https://doi.org/10.1002/adma.201401191>.
- Zhou, Ye, Yonghua Du, Shibo Xi, and Zhichuan J. Xu. 2017. "Spinel Manganese Ferrites for Oxygen Electrocatalysis: Effect of Mn Valency and Occupation Site." *Electrocatalysis*, October, 1–6.

<https://doi.org/DOI:10.1007/s12678-017-0429-z>.

- Zhou, Ye, Shengnan Sun, Jiajia Song, Shibo Xi, Bo Chen, Yonghua Du, Adrian C. Fisher, et al. 2018. "Enlarged Co-O Covalency in Octahedral Sites Leading to Highly Efficient Spinel Oxides for Oxygen Evolution Reaction." *Advanced Materials* 30 (32): 1802912. <https://doi.org/10.1002/adma.201802912>.
- Zhou, Ye, Shibo Xi, Jingxian Wang, Shengnan Sun, Chao Wei, Zhenxing Feng, Yonghua Du, and Zhichuan J. Xu. 2017. "Revealing the Dominant Chemistry for Oxygen Reduction Reaction on Small Oxide Nanoparticles." *ACS Catal.*, 2018 (8 (1)): pp 673–677. <https://doi.org/10.1021/acscatal.7b03864>.

C4T IRP3 — CAPRICORN

- Akroyd, Jethro William, Markus Kraft, and Philipp Buerger. 2018. "Extended First-Principles Thermochemistry for the Oxidation of Titanium Tetrachloride." *Combustion and Flame*, September. <https://doi.org/10.17863/cam.26962>.
- Amaniampong, Prince N., Quang Thang Trinh, Bo Wang, Armando Borgna, Yanhui Yang, and Samir H. Mushrif. 2015. "Biomass Oxidation: Formyl C-H Bond Activation by the Surface Lattice Oxygen of Regenerative CuO Nanoleaves." *Angewandte Chemie International Edition* 54 (31): 8928–33. <https://doi.org/10.1002/anie.201503916>.
- Azadi, Pooya, George Brownbridge, Immanuel Kemp, Sebastian Mosbach, John S. Dennis, and Markus Kraft. 2015. "Microkinetic Modeling of the Fischer-Tropsch Synthesis over Cobalt Catalysts." *ChemCatChem* 7 (1): 137–43. <https://doi.org/10.1002/cctc.201402662>.
- Azadi, Pooya, George Brownbridge, Sebastian Mosbach, Oliver Inderwildi, and Markus Kraft. 2015. "Simulation and Life Cycle Assessment of Algae Gasification Process in Dual Fluidized Bed Gasifiers." *Green Chem.* 17 (3): 1793–1801. <https://doi.org/10.1039/C4GC01698J>.
- Azadi, Pooya, George Brownbridge, Sebastian Mosbach, Andrew Smallbone, Amit Bhawe, Oliver Inderwildi, and Markus Kraft. 2014. "The Carbon Footprint and Non-Renewable Energy Demand of Algae-Derived Biodiesel." *Applied Energy* 113 (January): 1632–44. <https://doi.org/10.1016/j.apenergy.2013.09.027>.
- Azadi, Pooya, George P.E. Brownbridge, Sebastian Mosbach, Oliver R. Inderwildi, and Markus Kraft. 2014. "Production of Biorenewable Hydrogen and Syngas via Algae Gasification: A Sensitivity Analysis." In *Energy Procedia*, 61:2767–70. Taipei City, Taiwan. <https://doi.org/10.1016/j.egypro.2014.12.302>.
- Azadi, Pooya, Robert Malina, Steven R.H. Barrett, and Markus Kraft. 2017. "The Evolution of the Biofuel Science." *Renewable and Sustainable Energy Reviews* 76 (September): 1479–84. <https://doi.org/10.1016/j.rser.2016.11.181>.
- Boje, Astrid, Jethro Akroyd, Stephen Sutcliffe, John Edwards, and Markus Kraft. 2017. "Detailed Population Balance Modelling of TiO₂ Synthesis in an Industrial Reactor." *Chemical Engineering Science* 164: 219–31. <http://dx.doi.org/10.1016/j.ces.2017.02.019>.
- Botero, Maria L., Erin M. Adkins, Silvia González-Calera, Houston Miller, and Markus Kraft. 2016. "PAH Structure Analysis of Soot in a Non-Premixed Flame Using High-Resolution Transmission Electron Microscopy and Optical Band Gap Analysis." *Combustion and Flame* 164 (February): 250–58. <https://doi.org/10.1016/j.combustflame.2015.11.022>.
- Botero, Maria L., Dongping Chen, Silvia González-Calera, David Jefferson, and Markus Kraft. 2016. "HRTEM Evaluation of Soot Particles Produced by the Non-Premixed Combustion of Liquid Fuels." *Carbon* 96 (January): 459–73. <https://doi.org/10.1016/j.carbon.2015.09.077>.
- Botero, Maria L., Nick Eaves, Jochen A.H. Dreyer, Yuan Sheng, Jethro Akroyd, Wenming Yang, and Markus Kraft. 2018. "Experimental and Numerical Study of the Evolution of Soot Primary Particles in a Diffusion Flame." *Proceedings of the Combustion Institute*, July. <https://doi.org/doi.org/10.1016/j.proci.2018.06.185>.
- Botero, Maria L., Sebastian Mosbach, Jethro Akroyd, and Markus Kraft. 2015. "Sooting Tendency of Surrogates for the Aromatic Fractions of Diesel and Gasoline in a Wick-Fed Diffusion Flame." *Fuel* 153 (August): 31–39. <https://doi.org/10.1016/j.fuel.2015.02.108>.
- Botero, Maria L., Sebastian Mosbach, and Markus Kraft. 2014. "Sooting Tendency of Paraffin Components of Diesel and Gasoline in Diffusion Flames." *Fuel* 126 (June): 8–15. <https://doi.org/10.1016/j.fuel.2014.05.015>.

- doi.org/10.1016/j.fuel.2014.02.005.
- Botero, Maria L., Sebastian Mosbach, and Markus Kraft. 2016. "Sooting Tendency and Particle Size Distributions of N-Heptane/Toluene Mixtures Burned in a Wick-Fed Diffusion Flame." *Fuel* 169 (April): 111–19. <https://doi.org/10.1016/j.fuel.2015.12.014>.
 - Botero, Maria L., Anders Selmer, Roger Watson, Mukta Bansal, and Markus Kraft. 2016. "Cambridge Weblabs: A Process Control System Using Industrial Standard SIMATIC PCS 7." *Education for Chemical Engineers* 16 (July): 1–8. <https://doi.org/10.1016/j.ece.2016.04.001>.
 - Botero, Maria L., Yuan Sheng, Jethro Akroyd, Jacob Martin, Jochen A.H. Dreyer, Wenming Yang, and Markus Kraft. 2018. "Internal Structure of Soot Particles in a Diffusion Flame." *Carbon*, October. <https://doi.org/10.1016/j.carbon.2018.09.063>.
 - Brownbridge, George, Pooya Azadi, Andrew Smallbone, Amit Bhave, Benjamin Taylor, and Markus Kraft. 2014. "The Future Viability of Algae-Derived Biodiesel under Economic and Technical Uncertainties." *Bioresource Technology* 151 (January): 166–73. <https://doi.org/10.1016/j.biortech.2013.10.062>.
 - Buerger, Philipp, Jethro Akroyd, Jacob W. Martin, and Markus Kraft. 2016. "A Big Data Framework to Validate Thermodynamic Data for Chemical Species." *Combustion and Flame* 176: 584–91. <https://doi.org/10.1016/j.combustflame.2016.11.006>.
 - Buerger, Philipp, Jethro Akroyd, Sebastian Mosbach, and Markus Kraft. 2018. "A Systematic Method to Estimate and Validate Enthalpies of Formation Using Error-Cancelling Balanced Reactions." *Combustion and Flame* 187 (January): 105–21. <https://doi.org/10.1016/j.combustflame.2017.08.013>.
 - Buerger, Philipp, Daniel Nurkowski, Jethro Akroyd, and Markus Kraft. 2017. "A Kinetic Mechanism for the Thermal Decomposition of Titanium Tetraisopropoxide." *Proceedings of the Combustion Institute* 36 (1): 1019–27. <https://doi.org/10.1016/j.proci.2016.08.062>.
 - Buerger, Philipp, Daniel Nurkowski, Jethro Akroyd, Sebastian Mosbach, and Markus Kraft. 2015. "First-Principles Thermochemistry for the Thermal Decomposition of Titanium Tetraisopropoxide." *The Journal of Physical Chemistry A* 119 (30): 8376–87. <https://doi.org/10.1021/acs.jpca.5b01721>.
 - Camacho, Joaquin, Ajay V. Singh, Weijing Wang, Ruiqin Shan, Edward K.Y. Yapp, Dongping Chen, Markus Kraft, and Hai Wang. 2016. "Soot Particle Size Distributions in Premixed Stretch-Stabilized Flat Ethylene–Oxygen–Argon Flames." *Proceedings of the Combustion Institute* 36 (1): 1001–9. <https://doi.org/10.1016/j.proci.2016.06.170>.
 - Chen, Dongping, Jethro Akroyd, Sebastian Mosbach, and Markus Kraft. 2015. "Surface Reactivity of Polycyclic Aromatic Hydrocarbon Clusters." *Proceedings of the Combustion Institute* 35 (2): 1811–18. <https://doi.org/10.1016/j.proci.2014.06.140>.
 - Chen, Dongping, Jethro Akroyd, Sebastian Mosbach, Daniel Opalka, and Markus Kraft. 2015. "Solid–Liquid Transitions in Homogenous Ovalene, Hexabenzocoronene and Circumcoronene Clusters: A Molecular Dynamics Study." *Combustion and Flame* 162 (2): 486–95. <https://doi.org/10.1016/j.combustflame.2014.07.025>.
 - Chen, Dongping, Tim S. Totton, Jethro Akroyd, Sebastian Mosbach, and Markus Kraft. 2014a. "Phase Change of Polycyclic Aromatic Hydrocarbon Clusters by Mass Addition." *Carbon* 77 (October): 25–35. <https://doi.org/10.1016/j.carbon.2014.04.089>.
 - Chen, Dongping, Tim S. Totton, Jethro W.J. Akroyd, Sebastian Mosbach, and Markus Kraft. 2014b. "Size-Dependent Melting of Polycyclic Aromatic Hydrocarbon Nano-Clusters: A Molecular Dynamics Study." *Carbon* 67 (February): 79–91. <https://doi.org/10.1016/j.carbon.2013.09.058>.
 - Devanand, Aravind, Li Zhou, Iftekhar A. Karimi, and Markus Kraft. 2018. "An Ontology Based Cyber-Infrastructure for the Development of Smart Eco Industrial Parks." *Computer Aided Chemical Engineering* 44: 2047–52. <https://doi.org/10.1016/B978-0-444-64241-7.50336-0>.
 - Garud, Sushant S., Iftekhar A. Karimi, George P. E. Brownbridge, and Markus Kraft. 2017. "Evaluating Smart Sampling for Constructing Multidimensional Surrogate Models." *Computers & Chemical Engineering* 108: 276–88. <https://doi.org/10.1016/j.compchemeng.2017.09.016>.
 - Garud, Sushant S., Iftekhar A. Karimi, and Markus Kraft. 2016a. "Smart Adaptive Sampling for Surrogate Modelling." *Computer Aided Chemical Engineering* 38: 631–36. <https://doi.org/10.1016/B978-0-444-63428-3.50110-7>.

- Garud, Sushant S., Iftekhar A. Karimi, and Markus Kraft. 2016b. "Smart Sampling Algorithm for Surrogate Model Development." *Computers and Chemical Engineering* 96 (October): 103–14. <https://doi.org/10.1016/j.compchemeng.2016.10.006>.
- Garud, Sushant S., Iftekhar A. Karimi, and Markus Kraft. 2017. "Design of Computer Experiments: A Review." *Computers and Chemical Engineering* 106 (November): 71–95. <https://doi.org/10.1016/j.compchemeng.2017.05.010>.
- Garud, Sushant S., Iftekhar A. Karimi, and Markus Kraft. 2018. "LEAPS2: Learning Based Evolutionary Assistive Paradigm for Surrogate Selection." *Computers & Chemical Engineering*, September. <https://doi.org/10.1016/j.compchemeng.2018.09.008>.
- Grančič, Peter, Jacob W. Martin, Dongping Chen, Sebastian Mosbach, and Markus Kraft. 2016. "Can Nascent Soot Particles Burn from the Inside?" *Carbon* 109 (August): 608–15. <https://doi.org/10.1016/j.carbon.2016.08.025>.
- Han, Jianyu, Danping Wang, YongHua Du, Shibo Xi, Zhong Chen, Shengming Yin, Tianhua Zhou, and Rong Xu. 2015. "Polyoxometalate Immobilized in MIL-101(Cr) as an Efficient Catalyst for Water Oxidation." *Applied Catalysis A: General* 521 (December): 83–89. <https://doi.org/10.1016/j.apcata.2015.10.015>.
- Kastner, Catharine A., Raymond Lau, and Markus Kraft. 2015. "Quantitative Tools for Cultivating Symbiosis in Industrial Parks; a Literature Review." *Applied Energy* 155 (October): 599–612. <https://doi.org/10.1016/j.apenergy.2015.05.037>.
- Khaqqi, Khamila N., Janusz J. Sikorski, Kunn Hadinoto, and Markus Kraft. 2017. "Incorporating Seller/Buyer Reputation-Based System in Blockchain-Enabled Emission Trading Application." *Applied Energy* 209: 8–19. <https://doi.org/10.1016/j.apenergy.2017.10.070>.
- Kraft, Markus, and Wolfgang Wagner. 2017. "A Random Cloud Algorithm for the Schrödinger Equation." *Monte Carlo Methods and Applications* 23 (4). <https://doi.org/10.1515/mcma-2017-0118>.
- Lee, Kok Foong, John F. Davidson, Jethro Akroyd, and Markus Kraft. 2014. "Lifting a Buried Object: Reverse Hopper Theory." *Chemical Engineering Science* 105 (February): 198–207. <https://doi.org/10.1016/j.ces.2013.11.002>.
- Lee, Kok Foong, Maksym Dosta, Andrew McGuire, Sebastian Mosbach, Wolfgang Wagner, Stefan Heinrich, and Markus Kraft. 2017. "Development of a Multi-Compartment Population Balance Model for High-Shear Wet Granulation with Discrete Element Method." *Computers & Chemical Engineering* 99: 171–84. <https://doi.org/10.1016/j.compchemeng.2017.01.022>.
- Lee, Kok Foong, Sebastian Mosbach, Markus Kraft, and Wolfgang Wagner. 2015. "A Multi-Compartment Population Balance Model for High Shear Granulation." *Computers & Chemical Engineering* 75 (April): 1–13. <https://doi.org/10.1016/j.compchemeng.2015.01.009>.
- Lee, Kok Foong, Robert Patterson, Wolfgang Wagner, and Markus Kraft. 2015. "Stochastic Weighted Particle Methods for Population Balance Equations with Coagulation, Fragmentation and Spatial Inhomogeneity." *Journal of Computational Physics* 303: 1–18. <https://doi.org/10.1016/j.jcp.2015.09.031>.
- Li, Chunmei, Yonghua Du, Danping Wang, Shengming Yin, Wenguang Tu, Zhong Chen, Markus Kraft, Gang Chen, and Rong Xu. 2017. "Unique P-Co-N Surface Bonding States Constructed on g-C₃N₄ Nanosheets for Drastically Enhanced Photocatalytic Activity of H₂ Evolution." *Advanced Functional Materials* 27 (4): 1604328. <https://doi.org/10.1002/adfm.201604328>.
- Li, Jing, Wenming Yang, Hui An, Dezhi Zhou, and Markus Kraft. 2016. "Application of Dynamic ϕ -T Map: Analysis on a Natural Gas/Diesel Fueled RCCI Engine." *Journal of Engineering for Gas Turbines and Power* 138 (9): 092803. <https://doi.org/10.1115/1.4032712>.
- Lindberg, Casper, Jethro Akroyd, and Markus Kraft. 2017. "Developing Breakage Models Relating Morphological Data to the Milling Behaviour of Flame Synthesised Titania Particles." *Chemical Engineering Science* 166: 53–65. <https://doi.org/10.1016/j.ces.2017.03.016>.
- Manuputty, Manoel Y., Jethro Akroyd, Sebastian Mosbach, and Markus Kraft. 2017. "Modelling TiO₂ Formation in a Stagnation Flame Using Method of Moments with Interpolative Closure." *Combustion and Flame* 178 (January): 135–47. <https://doi.org/10.1016/j.combustflame.2017.01.005>.
- Martin, Jacob W., Maria Botero, Radomir I. Slavchov, Kimberly Bowal, Jethro Akroyd, Sebastian Mosbach, and Markus Kraft. 2018. "Flexoelectricity and the Formation of Carbon Nanoparticles in Flames." *The Journal of Physical Chemistry C* 122 (38): 22210–15. <https://doi.org/10.1021/>

- acs.jpcc.8b08264.
- Martin, Jacob W., Kimberly Bowal, Angiras Menon, Radomir I. Slavchov, Jethro Akroyd, Sebastian Mosbach, and Markus Kraft. 2018. "Polar Curved Polycyclic Aromatic Hydrocarbons in Soot Formation." *Proceedings of the Combustion Institute*, June. <https://doi.org/10.1016/j.proci.2018.05.046>.
 - Martin, Jacob W., Grant McIntosh, Rakesh Arul, Reece Oosterbeek, Markus Kraft, and Tilo Soehnel. 2017. "Giant Fullerene Formation through Thermal Treatment of Fullerene Soot." *Carbon* 125: 132–38. <https://doi.org/10.1016/j.carbon.2017.09.045>.
 - Martin, Jacob W., Radomir I. Slavchov, Edward K. Y. Yapp, Jethro Akroyd, Sebastian Mosbach, and Markus Kraft. 2017. "The Polarization of Polycyclic Aromatic Hydrocarbons Curved by Pentagon Incorporation: The Role of the Flexoelectric Dipole." *The Journal of Physical Chemistry C* 121 (48): 27154–27163. <https://doi.org/10.1021/acs.jpcc.7b09044>.
 - McGuire, Andrew, Kok Foong Lee, Maksym Dosta, Sebastian Mosbach, Jan-Georg Rosenboom, Stefan Heinrich, and Markus Kraft. 2017. "Compartmental Residence Time Estimation in Batch Granulators Using a Colourimetric Image Analysis Algorithm and Discrete Element Modelling." *Advanced Powder Technology* 28 (9): 2239–55. <https://doi.org/10.1016/j.apt.2017.06.005>.
 - Menz, William J., George P.E. Brownbridge, and Markus Kraft. 2014. "Global Sensitivity Analysis of a Model for Silicon Nanoparticle Synthesis." *Journal of Aerosol Science* 76 (October): 188–99. <https://doi.org/10.1016/j.jaerosci.2014.06.011>.
 - Mosbach, Sebastian, Je Hyeong Hong, George P. E. Brownbridge, Markus Kraft, Soumya Gudiyella, and Kenneth Brezinsky. 2014. "Bayesian Error Propagation for a Kinetic Model of N-Propylbenzene Oxidation in a Shock Tube." *International Journal of Chemical Kinetics* 46 (7): 389–404. <https://doi.org/10.1002/kin.20855>.
 - Mosbach, Sebastian, and Markus Kraft. 2015. "Influence of Experimental Observations on N-Propylbenzene Kinetic Parameter Estimates." *Proceedings of the Combustion Institute* 35 (1): 357–65. <https://doi.org/10.1016/j.proci.2014.05.061>.
 - Mosbach, Sebastian, William Menz, and Markus Kraft. 2016. "Outlier Analysis for a Silicon Nanoparticle Population Balance Model." *Combustion and Flame* 177: 89–97. <http://dx.doi.org/10.1016/j.combustflame.2016.12.006>.
 - Nurkowski, Daniel, Philipp Buerger, Jethro Akroyd, and Markus Kraft. 2015. "A Detailed Kinetic Study of the Thermal Decomposition of Tetraethoxysilane." *Proceedings of the Combustion Institute* 35 (2): 2291–98. <https://doi.org/10.1016/j.proci.2014.06.093>.
 - Nurkowski, Daniel, Philipp Buerger, Jethro Akroyd, Sebastian Mosbach, and Markus Kraft. 2016. "Skeletal Chemical Mechanism of High-Temperature TEOS Oxidation in Hydrogen–Oxygen Environment." *Combustion and Flame* 166 (April): 243–54. <https://doi.org/10.1016/j.combustflame.2016.01.025>.
 - Nurkowski, Daniel, Ahren Jasper, Jethro Akroyd, and Markus Kraft. 2017. "Theoretical Study of the Ti-Cl Bond Cleavage Reaction in TiCl_4 ." *Zeitschrift Fuer Physikalische Chemie* 231 (9): 1489–1506. <https://doi.org/10.1515/zpch-2016-0866>.
 - Nurkowski, Daniel, Stephen J. Klippenstein, Yuri Georgievskii, Marco Verdicchio, Ahren W. Jasper, Jethro Akroyd, Sebastian Mosbach, and Markus Kraft. 2015. "Ab Initio Variational Transition State Theory and Master Equation Study of the Reaction $(\text{OH})_3\text{SiOCH}_2 + \text{CH}_3 \rightleftharpoons (\text{OH})_3\text{SiOC}_2\text{H}_5$." *Zeitschrift Für Physikalische Chemie* 229 (5). <https://doi.org/10.1515/zpch-2014-0640>.
 - Ou, Man, Wenguang Tu, Shengming Yin, Weinan Xing, Shuyang Wu, Haojing Wang, Shipeng Wan, Qin Zhong, and Rong Xu. n.d. "Amino-Assisted Anchoring of CsPbBr_3 Perovskite Quantum Dots on Porous $\text{g-C}_3\text{N}_4$ for Enhanced Photocatalytic CO_2 Reduction." *Angewandte Chemie International Edition* 57. <https://doi.org/10.1002/anie.201808930>.
 - Pan, Ming, Janusz Sikorski, Jethro Akroyd, Sebastian Mosbach, Raymond Lau, and Markus Kraft. 2016. "Design Technologies for Eco-Industrial Parks: From Unit Operations to Processes, Plants and Industrial Networks." *Applied Energy* 175: 305–23. <https://doi.org/10.1016/j.apenergy.2016.05.019>.
 - Pan, Ming, Janusz Sikorski, Catharine A. Kastner, Jethro Akroyd, Sebastian Mosbach, Raymond Lau, and Markus Kraft. 2015. "Applying Industry 4.0 to the Jurong Island Eco-Industrial Park." In *Energy Procedia*, 75:1536–41. Abu Dhabi, United Arab Emirates. <https://doi.org/10.1016/>

j.egypro.2015.07.313.

- Sheng, Yuan, Maria L. Botero, Manoel Y. Manuputty, Markus Kraft, and Rong Xu. 2018. "Co₃O₄ and Fe_xCo_{3-x}O₄ Nanoparticles/Films Synthesized in a Vapor-Fed Flame Aerosol Reactor for Oxygen Evolution" 1 (2): 665–665. <https://doi.org/10.1021/acsaem.7b00172>.
- Sheng, Yuan, Markus Kraft, and Rong Xu. 2018. "Emerging Applications of Nanocatalysts Synthesized by Flame Aerosol Processes." *Current Opinion in Chemical Engineering* 20 (February): 39–49. <https://doi.org/10.1016/j.coche.2018.01.009>.
- Sikorski, Janusz, George Brownbridge, Sushant S. Garud, Sebastian Mosbach, Iftexhar A. Karimi, and Markus Kraft. 2016. "Parameterisation of a Biodiesel Plant Process Flow Sheet Model." *Computers & Chemical Engineering* 95: 108–22. <https://doi.org/10.1016/j.compchemeng.2016.06.019>.
- Sikorski, Janusz, Joy Haughton, and Markus Kraft. 2017. "Blockchain Technology in the Chemical Industry: Machine-to-Machine Electricity Market." *Applied Energy* 195: 234–46. <http://dx.doi.org/10.1016/j.apenergy.2017.03.039>.
- Smith, Alastair J., Clive G. Wells, and Markus Kraft. 2018. "A New Iterative Scheme for Solving the Discrete Smoluchowski Equation." *Journal of Computational Physics* 352 (January): 373–87. <https://doi.org/10.1016/j.jcp.2017.09.045>.
- Tan, Yong Ren, Maria L. Botero, Yuan Sheng, Jochen A.H. Dreyer, Rong Xu, Wenming Yang, and Markus Kraft. 2018. "Sooting Characteristics of Polyoxymethylene Dimethyl Ether Blends with Diesel in a Diffusion Flame." *Fuel* 224 (July): 499–506. <https://doi.org/10.1016/j.fuel.2018.03.051>.
- Tu W. G., Xu Y., Yin S. M., and Xu R. 2018. "Rational Design of Catalytic Centers in Crystalline Frameworks." <https://doi.org/10.1002/adma.201707582>.
- Tu, Wenguang, You Xu, Jiajia Wang, Bowei Zhang, Tianhua Zhou, Shengming Yin, Shuyang Wu, et al. 2017. "Investigating the Role of Tunable Nitrogen Vacancies in Graphitic Carbon Nitride Nanosheets for Efficient Visible-Light-Driven H₂ Evolution and CO₂ Reduction" 5 (8): 7260–68. <https://doi.org/10.1021/acssuschemeng.7b01477>.
- Tu, Wenguang, You Xu, Shengming Yin, and Rong Xu. n.d. "Rational Design of Catalytic Centers in Crystalline Frameworks." *Advanced Materials* 30 (33): 1707582. <https://doi.org/10.1002/adma.201707582>.
- Wang, Buyu, Sebastian Mosbach, Sebastian Schmutzhard, Shijin Shuai, Yaqing Huang, and Markus Kraft. 2016. "Modelling Soot Formation from Wall Films in a Gasoline Direct Injection Engine Using a Detailed Population Balance Model." *Applied Energy* 163: 154–66. <https://doi.org/10.1016/j.apenergy.2015.11.011>.
- Wu, Shaohua, Edward Yapp, Jethro Akroyd, Sebastian Mosbach, Rong Xu, Wenming Yang, and Markus Kraft. 2017. "Extension of Moment Projection Method to the Fragmentation Process." *Journal of Computational Physics* 335: 516–34. <https://doi.org/10.1016/j.jcp.2017.01.045>.
- Wu, Shaohua, Edward Yapp, Jethro Akroyd, Sebastian Mosbach, Wenming Yang, and Markus Kraft. 2017. "A Moment Projection Method for Population Balance Dynamics with a Shrinkage Term." *Journal of Computational Physics* 330: 960–80. <https://doi.org/10.1016/j.jcp.2016.10.030>.
- Wu, Shuyang, Weijing Wang, Wenguang Tu, Shengming Yin, Yuan Sheng, Manoel Manuputty, Markus Kraft, and Rong Xu. 2018. "Premixed Stagnation Flame Synthesized TiO₂ Nanoparticles with Mixed Phases for Efficient Photocatalytic Hydrogen Generation." *ACS Sustainable Chemistry & Engineering*, September. <https://doi.org/10.1021/acssuschemeng.8b03142>.
- Xu, You, Markus Kraft, and Rong Xu. 2016. "Metal-Free Carbonaceous Electrocatalysts and Photocatalysts for Water Splitting." *Chemical Society Reviews* 45 (11): 3039–52. <https://doi.org/10.1039/C5CS00729A>.
- Xu, You, Wenguang Tu, Bowei Zhang, Shengmin Yin, Yizhong Huang, Markus Kraft, and Rong Xu. 2017. "Nickel Nanoparticles Encapsulated in Few-Layer Nitrogen-Doped Graphene Derived from Metal–Organic Frameworks as Efficient Bifunctional Electrocatalysts for Overall Water Splitting." *Advanced Materials*, 1605957. <https://doi.org/10.1002/adma.201605957>.
- Yang, Wenming, Hui An, Jing Li, Dezhi Zhou, and Markus Kraft. 2015. "Impact of Urea Direct Injection on NO_x Emission Formation of Diesel Engines Fueled by Biodiesel." In , V002T04A005. ASME. <https://doi.org/10.1115/ICEF2015-1059>.
- Yang, Wenming, Kun Lin Tay, and Kah Wai Kong. 2017. "Impact of Various Factors on the Performance and Emissions of Diesel Engine Fueled by Kerosene and Its Blend with Diesel." In *Ener-*

- gy Procedia*, 142:1564–69. Proceedings of the 9th International Conference on Applied Energy. Cardiff, United Kingdom. <https://doi.org/10.1016/j.egypro.2017.12.609>.
- Yapp, Edward K. Y., Clive G. Wells, Jethro Akroyd, Sebastian Mosbach, Rong Xu, and Markus Kraft. 2017. "Modelling PAH Curvature in Laminar Premixed Flames Using a Detailed Population Balance Model." *Combustion and Flame* 176 (February): 172–80. <https://doi.org/10.1016/j.combustflame.2016.10.004>.
 - Yapp, Edward K.Y., Robert I.A. Patterson, Jethro Akroyd, Sebastian Mosbach, Erin M. Adkins, J. Houston Miller, and Markus Kraft. 2016. "Numerical Simulation and Parametric Sensitivity Study of Optical Band Gap in a Laminar Co-Flow Ethylene Diffusion Flame." *Combustion and Flame* 167 (May): 320–34. <https://doi.org/10.1016/j.combustflame.2016.01.033>.
 - Yin, Shengming, Jianyu Han, Yinjun Zou, Tianhua Zhou, and Rong Xu. 2016. "A Highly Efficient Noble Metal Free Photocatalytic Hydrogen Evolution System Containing MoP and CdS Quantum Dots." *Nanoscale* 8 (30): 14438–47. <https://doi.org/10.1039/C6NR00989A>.
 - Yin, Shengming, Wenguang Tu, Yuan Sheng, Yonghua Du, Markus Kraft, Armando Borgna, and Rong Xu. 2018. "A Highly Efficient Oxygen Evolution Catalyst Consisting of Interconnected Nickel-Iron-Layered Double Hydroxide and Carbon Nanodomains." *Advanced Materials* 30 (5): 1705106. <https://doi.org/10.1002/adma.201705106>.
 - Yu, Wenbin, Wenming Yang, Balaji Mohan, Kunlin Tay, Feiyang Zhao, Yunpeng Zhang, Siawkiang Chou, et al. 2016. "Numerical and Experimental Study on Internal Nozzle Flow and Macroscopic Spray Characteristics of a Kind of Wide Distillation Fuel (WDF) - Kerosene." *SAE International* 2016-01-0839. <https://doi.org/10.4271/2016-01-0839>.
 - Zhang, Chuan, Liwei Cao, and Alessandro Romagnoli. 2018. "On the Feature Engineering of Building Energy Data Mining." *Sustainable Cities and Society*, March. <https://doi.org/10.1016/j.scs.2018.02.016>.
 - Zhang, Chuan, Alessandro Romagnoli, Li Zhou, and Markus Kraft. 2017. "Knowledge Management of Eco-Industrial Park for Efficient Energy Utilization through Ontology-Based Approach." *Applied Energy* 204 (October): 1412–21. <https://doi.org/10.1016/j.apenergy.2017.03.130>.
 - Zhang, Chuan, Li Zhou, Pulkit Chhabra, Sushant S. Garud, Leonardus K. Aditya, Alessandro Romagnoli, Gabriele Comodi, Fabio Dal Magro, Antonella Meneghetti, and Markus Kraft. 2016. "A Novel Methodology for the Design of Waste Heat Recovery Network in Eco-Industrial Park Using Techno-Economic Analysis and Multi-Objective Optimization." *Applied Energy* 184: 88–102. <https://doi.org/10.1016/j.apenergy.2016.10.016>.
 - Zhang, Wei, Tianhua Zhou, Jindui Hong, and Rong Xu. 2016. "MoS₃ Loaded TiO₂ Nanoplates for Photocatalytic Water and Carbon Dioxide Reduction." *Journal of Energy Chemistry*, January. <https://doi.org/10.1016/j.jechem.2016.01.016>.
 - Zhang, Wei, Tianhua Zhou, Jianwei Zheng, Jindui Hong, Yunxiang Pan, and Rong Xu. 2015. "Water-Soluble MoS₃ Nanoparticles for Photocatalytic H₂ Evolution." *ChemSusChem* 8 (8): 1464–71. <https://doi.org/10.1002/cssc.201500067>.
 - Zhou, Dezhi, Wenming Yang, Hui An, Jing Li, and Markus Kraft. 2016. "An Enhanced Primary Reference Fuel Mechanism Considering Conventional Fuel Chemistry in Engine Simulation." *Journal of Engineering for Gas Turbines and Power* 138 (9): 092804. <https://doi.org/10.1115/1.4032713>.
 - Zhou, Dezhi, Wenming Yang, Jing Li, Kun Lin Tay, Siaw Kiang Chou, and Markus Kraft. 2017. "Efficient Combustion Modelling in RCCI Engine with Detailed Chemistry." In *Energy Procedia*, 105:1582–87. Beijing, China. <https://doi.org/10.1016/j.egypro.2017.03.504>.
 - Zhou, Dezhi, Wenming Yang, Jing Li, Kun Lin Tay, and Markus Kraft. 2017. "Combustion Modelling in RCCI Engines with a Hybrid Characteristic Time Combustion and Closed Reactor Model." *Applied Energy*. <https://doi.org/10.1016/j.apenergy.2017.08.137>.
 - Zhou, Li, Ming Pan, Janusz J. Sikorski, Sushant S. Garud, Leonardus K. Aditya, Martin J. Kleinlanghorst, Iftekhar A. Karimi, and Markus Kraft. 2017. "Towards an Ontological Infrastructure for Chemical Process Simulation and Optimization in the Context of Eco-Industrial Parks." *Applied Energy* 204 (October): 1284–98. <https://doi.org/10.1016/j.apenergy.2017.05.002>.
 - Zhou, Li, Chuan Zhang, Iftekhar. A. Karimi, and Markus Kraft. 2017. "J-Park Simulator, an Intelligent System for Information Management of Eco-Industrial Parks." *Energy Procedia* 142

- (December): 2953–58. <https://doi.org/10.1016/j.egypro.2017.12.313>.
- Zhou, Li, Chuan Zhang, Iftekhar A. Karimi, and Markus Kraft. 2018. “An Ontology Framework towards Decentralized Information Management for Eco-Industrial Parks.” *Computers & Chemical Engineering*, July. <https://doi.org/10.1016/j.compchemeng.2018.07.010>.
 - Zhou, Tianhua, Yonghua Du, Danping Wang, Shengming Yin, Wenguang Tu, Zhong Chen, Armando Borgna, and Rong Xu. 2017. “Phosphonate-Based Metal–Organic Framework Derived Co–P–C Hybrid as an Efficient Electrocatalyst for Oxygen Evolution Reaction” 7 (9): 6000–6007. <https://doi.org/10.1021/acscatal.7b00937>.
 - Zong, Yichen, Maria L. Botero, Liya E. Yu, and Markus Kraft. 2018. “Size Spectra and Source Apportionment of Fine Particulates in Tropical Urban Environment during Southwest Monsoon Season.” *Environmental Pollution*, October. <https://doi.org/10.1016/j.envpol.2018.09.124>.

C4T IRP4 — ICESO

- Biswas, Partha, Awad Noor, Suganthan Ponnuthurai, Ali Mostafa, and Amaratunga Gehan. 2017. “Minimizing THD of Multilevel Inverters with Optimal Values of DC Voltages and Switching Angles Using LSHADE-EpSin Algorithm.” In *2017 IEEE Congress on Evolutionary Computation (CEC)*. <https://doi.org/10.1109/CEC.2017.7969298>.
- Biswas, Partha P., P.N. Suganthan, Guohua Wu, and Gehan A.J. Amaratunga. 2019. “Parameter Estimation of Solar Cells Using Datasheet Information with the Application of an Adaptive Differential Evolution Algorithm.” *Renewable Energy* 132 (March): 425–38. <https://doi.org/10.1016/j.renene.2018.07.152>.
- Biswas, Partha, Suganthan Ponnuthurai, and Amaratunga Gehan. 2017. “Decomposition Based Multi-Objective Evolutionary Algorithm for Windfarm Layout Optimization.” *Renewable Energy, Elsevier* 115 (August): 326–37. <https://doi.org/10.1016/j.renene.2017.08.041>.
- Biswas, Partha, Mallipeddi Rammohan, Suganthan Ponnuthurai, and Amaratunga Gehan. 2017. “A Multiobjective Approach for Optimal Placement and Sizing of Distributed Generators and Capacitors in Distribution Network.” *Applied Soft Computing, Elsevier* 60: 268–80. <https://doi.org/10.1016/j.asoc.2017.07.004>.
- Biswas, Partha, Ponnuthurai N. Suganthan, and Gehan A. J. Amaratunga. 2017a. “Optimal Placement of Wind Turbines in a Windfarm Using L-SHADE Algorithm.” In *2017 IEEE Congress on Evolutionary Computation (CEC)*. <https://doi.org/10.1109/CEC.2017.7969299>.
- Biswas, Partha, Ponnuthurai N. Suganthan, and Gehan A. J. Amaratunga. 2017b. “Optimal Power Flow Solutions Incorporating Stochastic Wind and Solar Power.” *Energy Conversion and Management, Elsevier* 148 (July): 1194–1207. <https://doi.org/10.1016/j.enconman.2017.06.071>.
- Biswas, Partha, Ponnuthurai N. Suganthan, and Gehan A. J. Amaratunga. 2017c. “Minimizing Harmonic Distortion in Power System with Optimal Design of Hybrid Active Power Filter Using Differential Evolution.” *Applied Soft Computing, Elsevier* 61 (August): 486–96. <https://doi.org/10.1016/j.asoc.2017.08.031>.
- Biswas, Partha, Ponnuthurai N. Suganthan, Rammohan Mallipeddi, and Gehan A. J. Amaratunga. 2017. “Optimal Power Flow Solutions Using Differential Evolution Algorithm Integrated with Effective Constraint Handling Techniques.” *Engineering Applications of Artificial Intelligence* 68 (November): 81–100. <https://doi.org/10.1016/j.engappai.2017.10.019>.
- Chen, Tengpeng, Eddy Y.S. Foo, K. V. Ling, and Xuebing Chen. 2017. “Distributed State Estimation Using a Modified Partitioned Moving Horizon Strategy for Power Systems.” *Sensors* 17 ((10):2310). <https://doi.org/DOI:10.3390/s17102310>.
- Chen, Tengpeng, Ashok Krishnan, and Tri Tran. 2015. “Application of Partition-Based Moving Horizon Estimation to Power System State Estimation.” In *Proceedings of the 7th IEEE PES Asia-Pacific Power and Energy Engineering Conference (PES APPEEC'15)*, 1–5. Brisbane, Australia: IEEE. <https://doi.org/10.1109/APPEEC.2015.7380907>.
- Chen, Tengpeng, Tri Tran, Dexiang Zhou, W-K. Ho, and K. V. Ling. 2014. “Iterated Moving Horizon Estimation for Power Systems.” In *2014 International Conference on Control, Automation and Information Sciences (ICCAIS)*, 81–86. IEEE. <https://doi.org/10.1109/ICCAIS.2014.7020573>.
- Chen, Tengpeng, Dexiang Zhou, Tri Tran, Catharine Kastner, K. V. Ling, K-J. Tseng, and Jan M.

- Maciejowski. 2015. "Distributed Moving Horizon Estimation for Power Systems." In , 1–5. IEEE. <https://doi.org/10.1109/PESGM.2015.7286281>.
- Chen, Xuebing, Tengpeng Chen, King Jet Tseng, Yuhao Sun, and Gehan Amaratunga. 2016a. "Customized Optimal MPMU Placement Method for Distribution Networks." In , 135–40. IEEE. <https://doi.org/10.1109/APPEEC.2016.7779485>.
 - Chen, Xuebing, Tengpeng Chen, King Jet Tseng, Yuhao Sun, and Gehan A. J. Amaratunga. 2016b. "Hybrid Approach Based on Global Search Algorithm for Optimal Placement of MPMU in Distribution Networks." In , 559–63. IEEE. <https://doi.org/10.1109/ISGT-Asia.2016.7796445>.
 - Chen, Xuebing, King Jet Tseng, and Gehan A. J. Amaratunga. 2015. "State Estimation for Distribution Systems Using Micro-Synchrophasors." In *Proceedings of the 7th IEEE PES Asia-Pacific Power and Energy Engineering Conference (PES APPEEC'15)*, 1–5. Brisbane, Australia: IEEE. <https://doi.org/10.1109/APPEEC.2015.7381051>.
 - Dang, Thuy V., and K. V. Ling. 2014. "Moving Horizon Estimation on a Chip." In *2014 13th International Conference on Control Automation Robotics & Vision (ICARCV)*, 431–37. Singapore: IEEE. <https://doi.org/10.1109/ICARCV.2014.7064344>.
 - Dang, Thuy V., K. V. Ling, and Jan M. Maciejowski. 2015a. "Embedded ADMM-Based QP Solver for MPC with Polytopic Constraints." In , 3446–51. IEEE. <https://doi.org/10.1109/ECC.2015.7331067>.
 - Dang, Thuy V., K. V. Ling, and Jan M. Maciejowski. 2015b. "Embedded ADMM-Based Quadratic Programming Solver for Model Predictive Control with Polytopic Constraints." In *Proceedings of the European Control Conference (ECC'15)*, 3446–51. Linz, Austria: IEEE. <https://doi.org/10.1109/ECC.2015.7331067>.
 - Dang, Thuy V., K. V. Ling, and Daniel E. Quevedo. 2015. "Event-Triggered Anytime Control with Two Controllers." In *2015 54th IEEE Conference on Decision and Control (CDC)*, 4157–62. Osaka, Japan: IEEE. <https://doi.org/10.1109/CDC.2015.7402867>.
 - Dang, Thuy V., K. V. Ling, and D.E. Quevedo. n.d. "Stability Analysis of Event-Triggered Anytime Control with Multiple Control Laws." *IEEE Transactions on Automatic Control*. <https://doi.org/10.1109/TAC.2018.2833161>.
 - Dang, Thuy V., K-V. Ling, and Jan M. Maciejowski. 2017. "Banded Null Basis and ADMM for Embedded MPC." In *The 20th World Congress of the International Federation of Automatic Control*, 13712–17. Toulouse, France: International Federation of Automatic Control. <https://doi.org/10.1016/j.ifacol.2017.08.2172>.
 - Dang, Thuy V., Tri Tran, and K. V. Ling. 2015. "Numerical Algorithms for Quadratic Programming in Model Predictive Control - An Overview." In *Proceedings of International Conference on Modelling of Complex Systems and Environment*, 1–6. Danang, Vietnam. <https://doi.org/10.13140/RG.2.1.1885.4885>.
 - Foo, Eddy Y.S., Hoay Beng Gooi, and S. X. Chen. 2015. "Multi-Agent System for Distributed Management of Microgrids." *IEEE Transactions on Power Systems* 30 (1): 24–34. <https://doi.org/10.1109/TPWRS.2014.2322622>.
 - Ho, Weng Khuen, Tengpeng Chen, K.V. Ling, and Lu Sun. 2017. "Variance Analysis of Robust State Estimation in Power Systems Using Influence Function." *ELSEVIER, International Journal of Electrical Power & Energy Systems*, 92: 53–62. <https://doi.org/10.1016/j.ijepes.2017.04.009>.
 - Jayabarathi, T., T. Raghunathan, B. R. Adarsh, and Ponnuthurai N. Suganthan. 2016. "Economic Dispatch Using Hybrid Grey Wolf Optimizer." *Energy* 111 (September): 630–41. <https://doi.org/10.1016/j.energy.2016.05.105>.
 - Kaippilly Radhakrishnan, Krishnanand, Joymala Moirangthem, Sanjib Kumar Panda, and Gehan A.J. Amaratunga. 2018. "GIS Integrated Automation of a Near Real-Time Power-Flow Service for Electrical Grids." *IEEE Transactions on Industry Applications*, 1–1. <https://doi.org/10.1109/TIA.2018.2855645>.
 - Kamala, Srinivasa Rao. 2017. "Stability Enhancement Issues of Power Grid." In *Communication, Control and Security Challenges for the Smart Grid*, First, 1:405–50. IET Power and Energy 95. London, United Kingdom: The Institution of Engineering and Technology (IET). http://digital-library.theiet.org/content/books/10.1049/pbpo095e_ch14.
 - Krishnanand, K. R., Joymala Moirangthem, Saurabh Bhandari, and S. K. Panda. 2015. "Harmonic

- Load Modeling for Smart Microgrids." In , 68–72. IEEE. <https://doi.org/10.1109/ICBEST.2015.7435867>.
- Krishnanand, K. R., Joymala Moirangthem, and S. K. Panda. 2015. "Selective Harmonic Optimization for Flexible Single-Phase Operation of Cascaded H-Bridge Multilevel Inverters." In *Proceedings of the 1st Power, Communication and Information Technology Conference (PCITC'15)*, 918–23. Bhubaneswar, India: IEEE. <https://doi.org/10.1109/PCITC.2015.7438127>.
 - Lynn, Nandar, Rammohan Mallipeddi, and Ponnuthurai Nagaratnam Suganthan. 2015. "Differential Evolution with Two Subpopulations." In *Swarm, Evolutionary, and Memetic Computing*, edited by Bijaya Ketan Panigrahi, Ponnuthurai N. Suganthan, and Swagatam Das, 8947:1–13. Cham: Springer International Publishing. http://link.springer.com/10.1007/978-3-319-20294-5_1.
 - Moirangthem, Joymala, K. R. Krishnanand, S. K. Panda, and Gehan A. J. Amaratunga. 2016. "GIS Integrated Automation of a near Real-Time Power-Flow Service for Electrical Grids." In , 48–53. IEEE. <https://doi.org/10.1109/ICSET.2016.7811755>.
 - Patil, Bhagyesh V. 2015. "The Bernstein Branch-and-Prune Constrained Global Optimization Algorithm for MINLPs." In *Proceedings of the 6th International Conference on Mathematical Aspects of Computer and Information Sciences (MACIS'15)*. Berlin, Germany.
 - Patil, Bhagyesh V. 2016. "The Bernstein Branch-and-Prune Algorithm for Constrained Global Optimization of Multivariate Polynomial MINLPs." In *Mathematical Aspects of Computer and Information Sciences*, edited by Ilias S. Kotsireas, Siegfried M. Rump, and Chee K. Yap, 9582:560–75. Cham: Springer International Publishing. https://doi.org/10.1007/978-3-319-32859-1_48.
 - Patil, Bhagyesh V., Jan M. Maciejowski, and K. V. Ling. 2016. "Nonlinear Model Predictive Control Based on Bernstein Global Optimization with Application to a Nonlinear CSTR." In , 471–76. IEEE. <https://doi.org/10.1109/ECC.2016.7810329>.
 - Qiu, Xueheng, Ye Ren, Ponnuthurai N. Suganthan, and Gehan A. J. Amaratunga. 2017. "Empirical Mode Decomposition Based Ensemble Deep Learning for Load Demand Time Series Forecasting." *Applied Soft Computing* 54: 246–55. <https://doi.org/DOI10.1016/j.asoc.2017.01.015>.
 - Qiu, Xueheng, Ponnuthurai N. Suganthan, and Gehan A. J. Amaratunga. 2017. "Short-Term Electricity Price Forecasting with Empirical Mode Decomposition Based Ensemble Kernel Machines." In *Procedia Computer Science*, 108:1308–17. <https://doi.org/10.1016/j.procs.2017.05.055>.
 - Qiu, Xueheng, Le Zhang, Ye Ren, Ponnuthurai N. Suganthan, and Gehan A. J. Amaratunga. 2014. "Ensemble Deep Learning for Regression and Time Series Forecasting." In *2014 IEEE Symposium on Computational Intelligence in Ensemble Learning (CIEL)*, 1–6. Orlando, FL: IEEE. <https://doi.org/10.1109/CIEL.2014.7015739>.
 - Qiu, Xueheng, Le Zhang, Ponnuthurai N. Suganthan, and Gehan A. J. Amaratunga. 2017. "Oblique Random Forest Ensemble via Least Square Estimation for Time Series Forecasting." *Information Sciences* 420 (December): 249–62. <https://doi.org/10.1016/j.ins.2017.08.060>.
 - Qu, B. Y., J. J. Liang, Y. S. Zhu, and Ponnuthurai N. Suganthan. 2017. "Solving Dynamic Economic Emission Dispatch Problem Considering Wind Power by Multi-Objective Differential Evolution with Ensemble of Selection Method." *Natural Computing*, January, 1–9. <https://doi.org/10.1007/s11047-016-9598-6>.
 - Qu, B. Y., J. J. Liang, Y. S. Zhu, Z. Y. Wang, and Ponnuthurai N. Suganthan. 2016. "Economic Emission Dispatch Problems with Stochastic Wind Power Using Summation Based Multi-Objective Evolutionary Algorithm." *Information Sciences* 351 (July): 48–66. <http://dx.doi.org/10.1016/j.ins.2016.01.081>.
 - Ray, Prakash K., Shiba R. Paital, Asit Mohanty, Foo Y.S. Eddy, and Hoay Beng Gooi. 2018. "A Robust Power System Stabilizer for Enhancement of Stability in Power System Using Adaptive Fuzzy Sliding Mode Control." *Applied Soft Computing* 73 (December): 471–81. <https://doi.org/10.1016/j.asoc.2018.08.033>.
 - Ray, Prakash K., Basanta K. Panigrahi, Pravat K. Rout, Asit Mohanty, Foo Y. S. Eddy, and Hoay Beng Gooi. 2018. "Detection of Islanding and Fault Disturbances in Microgrid Using Wavelet Packet Transform." *IETE Journal of Research*, May, 1–14. <https://doi.org/10.1080/03772063.2018.1454344>.
 - Ren, Ye, Xueheng Qiu, and Ponnuthurai N. Suganthan. 2014. "Empirical Mode Decomposition Based Adaboost-Backpropagation Neural Network Method for Wind Speed Forecasting." In *2014*

IEEE Symposium on Computational Intelligence in Ensemble Learning (CIEL), 1–6. Orlando, FL: IEEE. <https://doi.org/10.1109/CIEL.2014.7015741>.

- Ren, Ye, Xueheng Qiu, Ponnuthurai N. Suganthan, and Gehan Amaratunga. 2015. “Detecting Wind Power Ramp with Random Vector Functional Link (RVFL) Network.” In *Proceedings of 2015 IEEE Symposium Series on Computational Intelligence*, 687–94. Cape Town, South Africa: IEEE. <https://doi.org/10.1109/SSCI.2015.105>.
- Ren, Ye, Ponnuthurai N. Suganthan, N. Srikanth, and Gehan A. J. Amaratunga. 2015. “Random Vector Functional Link Network for Short-Term Electricity Load Demand Forecasting.” *Information Sciences* 367–368: 1078–93. <https://doi.org/10.1016/j.ins.2015.11.039>.
- Ren, Ye, Le Zhang, and Ponnuthurai N. Suganthan. 2016. “Ensemble Classification and Regression—Recent Developments, Applications and Future Directions.” *IEEE Computational Intelligence Magazine* 11 (1): 41–53. <https://doi.org/10.1109/MCI.2015.2471235>.
- Rigo-Mariani, Rémy, K. V. Ling, and Jan M. Maciejowski. 2018. “A Generic Method to Model CO₂ Emission Performances of Combined-Cycle Power Plants for Environmental Unit Commitment.” *Energy Technology*, CREATE Research Campus, 6 (1): 72–83. <https://doi.org/10.1002/ente.201700552>.
- Sampath, L.P.M.I., Bhagyesh V. Patil, H.B. Gooi, J.M. Maciejowski, and K.V. Ling. 2018. “A Trust-Region Based Sequential Linear Programming Approach for AC Optimal Power Flow Problems.” *Electric Power Systems Research* 165 (December): 134–43. <https://doi.org/10.1016/j.epsr.2018.09.002>.
- Sun, Lu, Tengpeng Chen, Xuebing Chen, Weng Khuen Ho, Keck-Voon Ling, King-Jet Tseng, and Gehan A. J. Amaratunga. 2018. “Optimum Placement of Phasor Measurement Units in Power Systems.” *IEEE Transactions on Instrumentation and Measurement* PP (99): 1–9. <https://doi.org/10.1109/TIM.2018.2851838>.
- Sun, Yuhao, Xuebing Chen, Shiliang Yang, Rusli, King Tseng, and Gehan Amaratunga. 2017. “Micro PMU Based Monitoring System for Active Distribution Networks.” In . Hawaii, USA. <https://doi.org/10.1109/PEDS.2017.8289180>.
- Tran, Tri. 2014. “State Feedback Control of Explicitly-Bounded Nonlinearly-Coupled Interconnected Systems.” In *2014 International Conference on Control, Automation and Information Sciences (ICCAIS)*, 30–35. IEEE. <https://doi.org/10.1109/ICCAIS.2014.7020563>.
- Tran, Tri. 2015a. “Self-Reliant Control Systems.” In *Proceedings of the 5th International Conference on Control, Automation and Information Science (IEEE)*. Seoul, South Korea: IEEE.
- Tran, Tri. 2015b. “A New Architecture for Reliable Computerized-Control System via IoT Enabled Connectivity.” In *Proceedings of the International Conference on Modelling of Complex Systems and Environment*, 6–9. Danang, Vietnam. <https://doi.org/10.13140/RG.2.1.2934.0649>.
- Tran, Tri. 2015c. “Periodic Economic Model Predictive Control with Bounded-State Stability.” In *Proceedings of the 5th Australian Control Conference (AUCC'15)*, 253–58. Gold Coast, Australia: IEEE. <http://ieeexplore.ieee.org/document/7361943/>.
- Tran, Tri. 2016. “A Private Machine-Cloud Architecture and Self-Reliant Controllers for Operational Technology Systems.” In *Proceedings of 2016 International Conference on Control, Automation and Information Sciences*, 214–19. Ansan, Seoul, Korea: IEEE. <https://doi.org/10.1109/ICCAIS.2016.7822458>.
- Tran, Tri. 2017a. “Application of GDC to the Automatic Generation Control Problem.” In *Proceedings of the 6th International Conference on Control, Automation and Information Science (IEEE)*. Thailand: IEEE. <http://ieeexplore.ieee.org/xpl/conhome.jsp?punumber=1802677>.
- Tran, Tri. 2017b. “Linear Matrix Inequalities for Dissipative Constraints in Stabilization with Relaxed Non-Monotonic Lyapunov Function.” In *Proceedings of the 6th International Conference on Control, Automation and Information Science (IEEE)*. Thailand: IEEE. <http://ieeexplore.ieee.org/xpl/conhome.jsp?punumber=1802677>.
- Tran, Tri. 2017c. “Stability from the Stabilization with General Dissipativity Constraint.” In *Proceedings of the 6th International Conference on Control, Automation and Information Science (IEEE)*. Thailand: IEEE. <http://ieeexplore.ieee.org/xpl/conhome.jsp?punumber=1802677>.
- Tran, Tri, and Tengpeng Chen. 2015. “Dissipativity Constraint for Distributed Power System State Estimation.” In *Proceedings of the 4th International Conference on Control, Automation, and Information*

Science (ICCAIS'15), 360–65. Changshu, China: IEEE. <https://doi.org/10.1109/ICCAIS.2015.7338693>.

- Tran, Tri, and Q. P. Ha. 2014. “Dependable Control Systems with Self-Recovery Constraint.” In *2014 International Conference On Control, Automation and Information Sciences (ICCAIS)*, 87–92. IEEE. <https://doi.org/10.1109/ICCAIS.2014.7020574>.
- Tran, Tri, and Q. P. Ha. 2015a. “Modeling of Washing Circuits in Mining - A Networked System Approach.” In *Proceedings of International Conference on Modelling of Complex Systems and Environment*, 123–31. Danang, Vietnam. <https://doi.org/10.13140/RG.2.1.1744.1767>.
- Tran, Tri, and Q. P. Ha. 2015b. “Dependable Control Systems with Internet of Things.” *ISA Transactions*, August. <https://doi.org/10.1016/j.isatra.2015.08.008>.
- Tran, Tri, and Q. P. Ha. 2017. “Perturbed Cooperative-State Feedback Strategy for Model Predictive Networked Control of Interconnected Systems.” *ISA Transactions* 72 (September): 110–21. <https://doi.org/doi.org/10.1016/j.isatra.2017.09.017>.
- Tran, Tri, and Q. P. Ha. 2018. *A Quadratic Constraint Approach to Model Predictive Control of Interconnected Systems*. 1st ed. Springer Nature Singapore. <http://www.springer.com/in/book/9789811084072>.
- Tran, Tri, K. V. Ling, and Jan M. Maciejowski. 2014a. “Economic Model Predictive Control - A Review.” In *Proceedings of the 31st ISARC, Sydney, Australia*, 35–42. The 31st International Symposium on Automation and Robotics in Construction and Mining (ISARC 2014). http://www.iaarc.org/publications/2014_proceedings_of_the_31st_isarc_sydney_australia/economic_model_predictive_control_a_review.html.
- Tran, Tri, K. V. Ling, and Jan M. Maciejowski. 2014b. “Closed-Loop Development for Dissipativity Constraint.” In *2014 International Conference On Control, Automation and Information Sciences (ICCAIS)*, 24–29. IEEE. <https://doi.org/10.1109/ICCAIS.2014.7020562>.
- Tran, Tri, K. V. Ling, and Jan M. Maciejowski. 2014c. “Model Predictive Control via Quadratic Dissipativity Constraint.” In *2014 IEEE 53rd Annual Conference on Decision and Control (CDC)*, 6689–94. IEEE. <https://doi.org/10.1109/CDC.2014.7040439>.
- Tran, Tri, K. V. Ling, Jan M. Maciejowski, and Eddy Y.S. Foo. 2014. “Application of Quadratically-Constrained Model Predictive Control in Power Systems.” In *2014 13th International Conference on Control Automation Robotics & Vision (ICARCV)*, 193–98. IEEE. <https://doi.org/10.1109/ICARCV.2014.7064303>.
- Tran, Tri, and Jan M. Maciejowski. 2016. “Control with General Dissipativity Constraint and Non-Monotonic Lyapunov Functions.” In *Proceedings of 2016 International Conference on Control, Automation and Information Sciences*, 177–82. Ansan, Seoul, Korea: IEEE. <https://doi.org/10.1109/ICCAIS.2016.7822456>.
- Tran, Tri, Jan M. Maciejowski, and K. V. Ling. 2014. “Model Predictive Control of Nonlinear Input-Affine Systems with Feasibility and Stability Constraints.” In *2014 13th International Conference on Control Automation Robotics & Vision (ICARCV)*, 992–97. IEEE. <https://doi.org/10.1109/ICARCV.2014.7064441>.
- Tran, Tri, Jan M. Maciejowski, and K. V. Ling. 2016. “A General Dissipativity Constraint for Feedback System Synthesis and Design.” *Systems and Control Letters*.
- Tran, Tri, and M-H Nguyen. 2015. “A Miniature Distributed Power Hardware-In-The-Loop (DPHIL) Power System Simulator with Reduced Voltage and Reduced Power Components.” In *Proceedings of International Conference on Modelling of Complex Systems and Environment*, 43–47. Danang, Vietnam. <https://doi.org/10.13140/RG.2.1.1230.1280>.
- Tran, Tri, D. Zhou, K. V. Ling, and Jan M. Maciejowski. 2015. “Multiplexed Model Predictive Control of Interconnected Systems.” In *Proceedings of IEEE Conference on Decision and Control (CDC'14)*, 15–17. Los Angeles, CA: IEEE. <https://doi.org/10.1109/CDC.2014.7040439>.
- Yu, Chao, Qing-Guo Wang, Dan Zhang, Lei Wang, and Jiangshuai Huang. 2015. “System Identification in Presence of Outliers.” *IEEE Transactions on Cybernetics*, 1–1. <https://doi.org/10.1109/TCYB.2015.2430356>.
- Zhang, Tian, Shuai-Xun Chen, Hoay Beng Gooi, and Jan M. Maciejowski. 2017. “A Hierarchical EMS for Aggregated BESSs in Energy and Performance-Based Regulation Markets.” *IEEE Transactions on Power Systems* 32 (3): 1751–60. <https://doi.org/10.1109/TPWRS.2016.2598186>.



VISITING SCIENTISTS

CARES C4T VISITING SCIENTISTS PROGRAMME

Professor Alan Bond

Monash University

Unexpectedly stable formally platinum(III) complexes produced by electrochemical oxidation of platinum(II) anti-cancer drugs

In this lecture, the synthesis, characterisation and biological activity of some new anti-cancer organoamidoplatinum(II) Class 2 drugs will be presented along with an introduction to the chemistry of their oxidised Pt(III) analogues. In the case of $[\text{Pt}\{\{\text{pYC}_6\text{F}_4\}\text{NCH}_2\text{CH}_2\text{NEt}_2\}\text{X}(\text{py})]$ (Y= H, Br; and X= Cl, Br, I), structural isomers have been isolated and crystallographic properties including agostic interactions, inter and intramolecular H-bonding and other supramolecular interactions have been explored that may be relevant to their DNA-binding properties. In vitro testing of the anticancer behaviour against MCF-7 and HT-29 cell lines revealed the high activity of these drugs. Chemical oxidation with hydrogen peroxide provides new ligand oxidised platinum(II)

complexes that represent another potential source of anti-cancer drugs. In contrast, electrochemical conditions have been identified that favour the generation of formally metal centre oxidised platinum(III) rather than ligand oxidised species. EPR, UV-Vis and IR and XFAS methods have been used to characterise the unexpectedly stable platinum(III) species. Slow rearrangement of some of the monomeric platinum(III) species to their ligand oxidised counterparts formed by peroxidised oxidation has been probed by ^1H , ^{19}F and ^{195}Pt NMR and UV-Vis spectroscopy. The Pt^{III} organoamineamide isolated by chemical oxidation gives a completely stable monomeric platinum(III) cation upon electrochemical oxidation for reasons that will be outlined.





Dr Nishu Goyal

University of Petroleum and Energy Studies

Role of genome-scale modelling for improving methanogenesis in *M. maripaludis*

Exhaust flue gas generated during combustion of fossil fuels such as coal accounts for about 11% of CO₂ emissions worldwide. To reduce these carbon emissions, cost-effective, clean and efficient approaches are needed to capture the CO₂ from flue gas and convert it into a relatively cleaner and sustainable fuel such as methane. *M. maripaludis* is a fast growing, mesophilic, hydrogenotrophic methanogen which reduces CO₂ (an electron acceptor) with the help of H₂ (an electron donor) for growth and methanogenesis. Despite several decades of research on *M. maripaludis*, a consolidated review on its metabolic processes and applications was lacking in the literature. In addition, efforts to generate a systems biology model for *M. maripaludis* have not been successful. We initiated the system level analysis and successfully reconstructed the first

genome-scale metabolic model (iMM518) of *M. maripaludis*. For model validation, we performed batch culture experiments and quantified three key extracellular fluxes (CO₂, H₂, and CH₄) along with specific growth rates of *M. maripaludis*. A novel process simulation approach was used to accurately estimate these fluxes. Exceptionally high consumption and production rates were observed in *M. maripaludis* with a growth yield of 3.549±0.149 gDCW/mol CH₄. The experimental results indicated that *M. maripaludis* was capable of reducing 70-95% of CO₂ to CH₄ during the exponential phase. We further explored the nitrogen-fixing ability of *M. maripaludis* and performed batch culture studies on *M. maripaludis* to compare the impact of NH₄⁺ or N₂ on methane production. Our results show that with the same amount of nutrients in both the reactors, N₂-fixation allows methane production for more than 30 days and hence provides an ideal scenario for dual capture of carbon and nitrogen from flue gas.

**Professor Oliver Inderwildi
mm1 Consulting & Management**

The paradox of plenty: The competitive advantage of smart, resource-poor economies

The resource curse, aka the paradox of plenty, refers to the well-established fact that countries with an abundance of natural resources tend to develop more slowly while their economies grow at lower rates, compared to countries with limited natural resources. This is illustrated by the fact that the some of the most resource-poor countries, such as Singapore and Switzerland, are among the most innovative and richest economies in the world. Is this pure luck or due to efficient use of resources, smart polices and ingenuity in trade and business?



This presentation will recap and build on a lecture given at CREATE in 2016 in which resource use in Singapore was discussed and the advantages of Singaporean resource management were highlighted. This subsequent presentation will discuss how the apparent disadvantage of resource poverty is transformed into advantage using smart policy frameworks ranging from economic incentives to regulation.

Through the CARES C4T Visiting Scientists Programme, expert researchers from around the world are invited to spend time at C4T in Singapore. These researchers visited CARES C4T and hosted seminars during the reporting period.



CAMBRIDGE
CARES

**This research is funded by the National Research Foundation, Prime Minister's Office, Singapore under its
Campus for Research Excellence and Technological Enterprise (CREATE) programme.**